

DIURNAL PLANT GROWTH CHAMBER



115 Voltage



Installation - Operation Manual

SRI21D

Not for Fly Cultivation

This unit is not designed to hold **fruit flies** (*Drosophila melanogaster*). Use with flies voids the manufacturing warranty and risks damaging the unit.

Other incubator models in the SRI family are manufactured specifically for fly applications. Talk to your distributor or customer service representative to identify a model compatible with your study or production model.

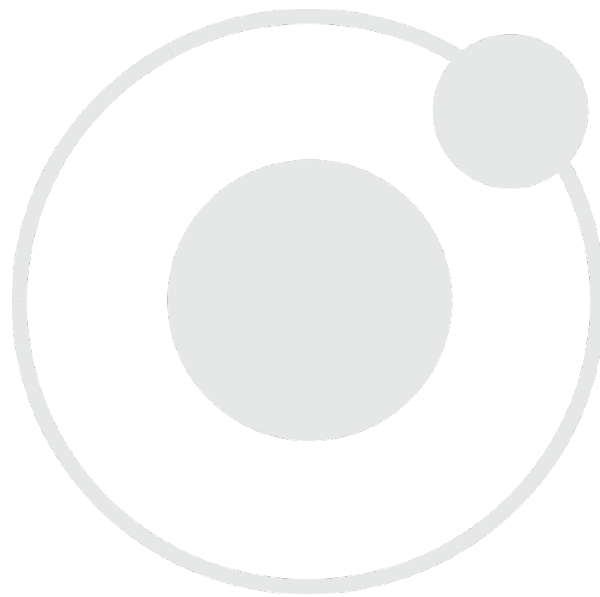

SRI21D DIURNAL PLANT GROWTH CHAMBER

115 Voltage

Installation and Operation Manual

Part Number (Manual): 4861744

Revision: February 12, 2018



These units are compliant with the following standards for use within an ambient air pressure range of 22.14 – 31.3 inHg (75 – 106 kPa), with no flammable, volatile, or combustible materials being heated.

CAN/CSA C22.2 No. 61010-1:2012

CAN/CSA C22.2 No. 61010-2-010:2004 Reaffirmed: 2014-07

UL 61010-1:2012-05

UL 61010A-2-010:2002-03

EN 61010-1:2010

EN 61010-2-010:2014

Supplemented by: UL 61010-2-010:2015

TABLE OF CONTENTS

INTRODUCTION	5
<i>Read this Manual.....</i>	5
<i>Safety Considerations and Requirements</i>	5
<i>Contacting Assistance</i>	6
<i>Engineering Improvements.....</i>	6
<i>Temperature Reference Sensor Device</i>	7
RECEIVING YOUR UNIT	9
<i>Inspect the Shipment.....</i>	9
<i>Orientation Photo</i>	10
<i>Recording Data Plate Information</i>	11
INSTALLATION	13
<i>Installation Checklist</i>	13
<i>Required Ambient Conditions.....</i>	14
<i>Environmental Disruption Sources.....</i>	14
<i>Power Source Requirements</i>	15
<i>Lifting and Handling</i>	15
<i>Install the Chamber in Location</i>	16
<i>Leveling.....</i>	16
<i>Attach the Chamber Door Handle</i>	16
<i>Adjust Shelves.....</i>	17
<i>Deionized and Distilled Water.....</i>	18
<i>Installation Cleaning and Disinfection</i>	18
GRAPHIC SYMBOLS	19
CONTROL PANEL OVERVIEW	21
OPERATION.....	23
<i>Theory of Operation</i>	23
<i>Put the Chamber into Operation.....</i>	25
<i>Set the Manual Day Mode Temperature Set Point</i>	26
<i>Set the Manual Night Mode Temperature Set Point.....</i>	29
<i>Program Clock Times and Cycle Temperature Set Points.....</i>	32
<i>Load the Chamber</i>	38
<i>Condensation and the Dew Point</i>	38
<i>Launching the Day - Night Cycle</i>	39
<i>Accessory Compatibility and Power Outlet</i>	39
<i>Set the Over Temperature Limit.....</i>	40
USER MAINTENANCE.....	41
<i>Cleaning and Disinfecting.....</i>	41
<i>Minimizing Contamination Exposure</i>	42
<i>Electrical Components</i>	42
<i>Refrigeration and Defrosting.....</i>	43
<i>Diagnostics - Temperature Issues.....</i>	59
UNIT SPECIFICATIONS	67
<i>Weight.....</i>	67
<i>Dimensions.....</i>	67
<i>Capacity</i>	67
<i>Max Shelves For Unit</i>	68
<i>Shelf Capacity by Weight.....</i>	68
<i>Temperature</i>	68
<i>Power.....</i>	68
PARTS AND CONSUMABLES.....	69

INTRODUCTION

Thank you for purchasing a SHEL LAB unit. We know you have many choices in today's competitive marketplace when it comes to constant temperature equipment. We appreciate you choosing ours. We stand behind our products and will be here for you if you need us.

READ THIS MANUAL

Failure to follow the guidelines and instructions in this user manual may create a protection impairment by disabling or interfering with the unit safety features. This can result in injury or death.

Before using the unit, read the manual in its entirety to understand how to install, operate, and maintain the unit in a safe manner. Keep this manual available for use by all operators. Ensure all operators are given appropriate training before the unit begins service.

SAFETY CONSIDERATIONS AND REQUIREMENTS

Follow basic safety precautions, including all national laws, regulations, and local ordinances in your area regarding the use of this unit. If you have any questions about local requirements, please contact the appropriate agencies.

SOPs

Because of the range of potential applications, this unit can be used for, the operator or their supervisors must draw up a site-specific standard operating procedure (SOP) covering each application and associated safety guidelines. This SOP must be written and available to all operators in a language they understand.

Intended Applications and Locations

The incubators are intended for constant temperature, non-humidified general incubation applications in professional, industrial, and educational environments. The units are not intended for use at hazardous or household locations.

Power

Your unit and its recommended accessories are designed and tested to meet strict safety requirements.

- The unit is designed to connect to a power source using the specific power cord type shipped with the unit.
- Always plug the unit power cord into a protective earth grounded electrical outlet conforming to national and local electrical codes. If the unit is not grounded properly, parts such as knobs and controls can conduct electricity and cause serious injury.
- Do not bend the power cord excessively, step on it, or place heavy objects on it.
- A damaged cord can be a shock or fire hazard. Never use a power cord if it is damaged or altered in any way.
- Use only approved accessories. Do not modify system components. Any alterations or modifications to your unit not explicitly authorized by the manufacturer can be dangerous and will void your warranty.

CONTACTING ASSISTANCE

Phone hours for Sheldon Technical Support are 6 am – 4:30 pm Pacific Coast Time (west coast of the United States, UTC -8), Monday – Friday. Please have the following information ready when calling or emailing Technical Support: the **model number** and the **serial number** (see page 11).

EMAIL: support@sheldonmfg.com

PHONE: 1-800-322-4897 extension 4, or (503) 640-3000

FAX: (503) 640-1366

Sheldon Manufacturing, INC.

P.O. Box 627

Cornelius, OR 97113

ENGINEERING IMPROVEMENTS

Sheldon Manufacturing continually improves all of its products. As a result, engineering changes and improvements are made from time to time. Therefore, some changes, modifications, and improvements may not be covered in this manual. If your unit's operating characteristics or appearance differs from those described in this manual, please contact your SHEL LAB dealer or customer service representative for assistance.

TEMPERATURE REFERENCE SENSOR DEVICE

Must be purchased separately

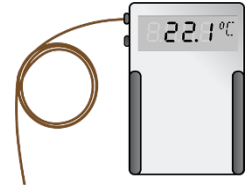

Temperature Reference

A reference sensor device is required for calibrating the incubator temperature display.

Reference devices must meet the following standards:

- Accurate to at least 0.1°C

The device should be regularly calibrated, preferably by a third party.

Temperature Probe

Use a digital device with a wire thermocouple probe that can be introduced into the incubation chamber through the unit access port. Select a thermocouple suitable for the application temperature you will be calibrating at.

Why a Probe?

Reference readings taken outside the chamber using wire temperature probes avoid chamber door openings. Openings disrupt the chamber temperature. Each disruption requires **a minimum 1-hour wait** to allow the atmosphere to re-stabilize before continuing.

No Alcohol or Mercury Thermometers

Alcohol thermometers do not have sufficient accuracy to conduct accurate temperature calibrations. **Never place a mercury thermometer in the incubation chamber!** Always use thermocouple probes.

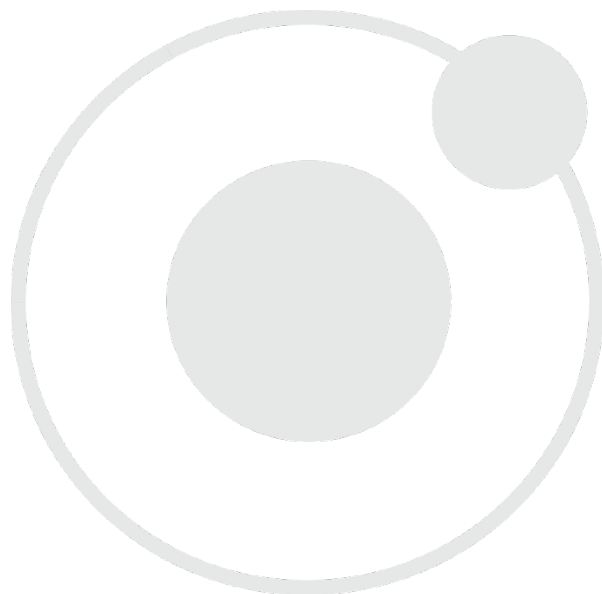

INSPECT THE SHIPMENT

- When a unit leaves the factory, **safe delivery becomes the responsibility of the carrier.**
- Damage sustained during transit is not covered by the manufacturing defect warranty.

When you receive your unit, inspect it for concealed loss or damage to its interior and exterior. If you find any damage to the unit, **follow the carrier's procedure for claiming damage or loss.**

1. Carefully inspect the shipping carton for damage.
2. Report any damage to the carrier service that delivered the unit.
3. If the carton is not damaged, open the carton and remove the contents.
4. The unit should come with an Installation and Operation Manual.
5. Verify that the correct number of accessories has been included.
 - 4 shelves
 - 1 chamber door key
 - 1 Chamber door handle with installation instructions

RECEIVING YOUR UNIT

ORIENTATION PHOTO

Figure 1: SRI21D



RECEIVING YOUR UNIT

RECORDING DATA PLATE INFORMATION

The unit data plate contains the chamber **model number** and **serial number**. Record this information below for future reference.

- The data plate is located on the unit exterior, on the top, right side.

Model Number	
Serial Number	

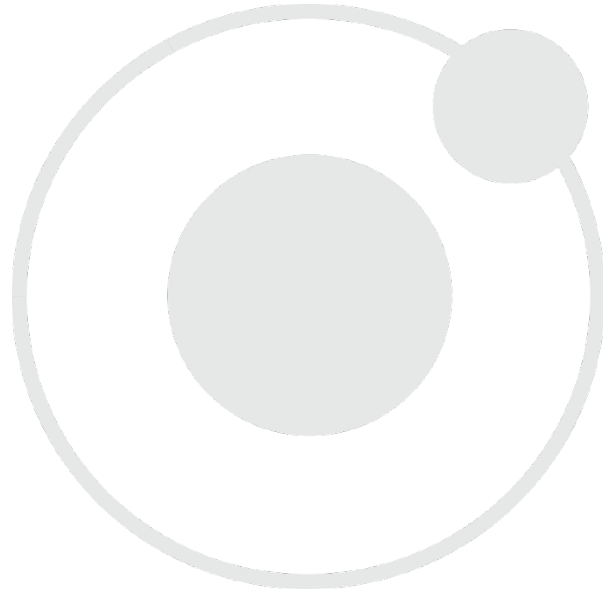

INSTALLATION CHECKLIST

For installing the unit in a new workspace.

Pre-Installation

- ✓ Check that the required ambient conditions, ventilation, and spacing for the chamber are met, page 14.
 - Unit dimensions may be found on page 67
- ✓ Check for performance-disrupting heat and cold sources in the environment, page 14
- ✓ Check that a suitable electrical outlet and power supply is present, page 15

Install the Chamber in a suitable workspace location

- ✓ Review the lifting and handling instructions, page 15
- ✓ Install the chamber in its workspace location, page 15
- ✓ Make sure the chamber is level, page 16

Set up the Chamber for use

- ✓ Install the chamber door handle, page 16
- ✓ Verify that all packaging has been removed from the chamber shelving and incubation chamber, page 17
- ✓ Clean the cultivation chamber if needed, page 18

INSTALLATION

REQUIRED AMBIENT CONDITIONS

The SRI chambers are intended for use indoors at room temperatures between **15°C and 30°C (59°F and 86°F)**, at no greater than an ambient **80% Relative Humidity** (at 25°C / 77°F). Allow a minimum of **4 inches (100 mm)** between the unit and walls or partitions, and **2.5 inches (60 mm)** of clearance above the top of the chamber for unobstructed airflow.

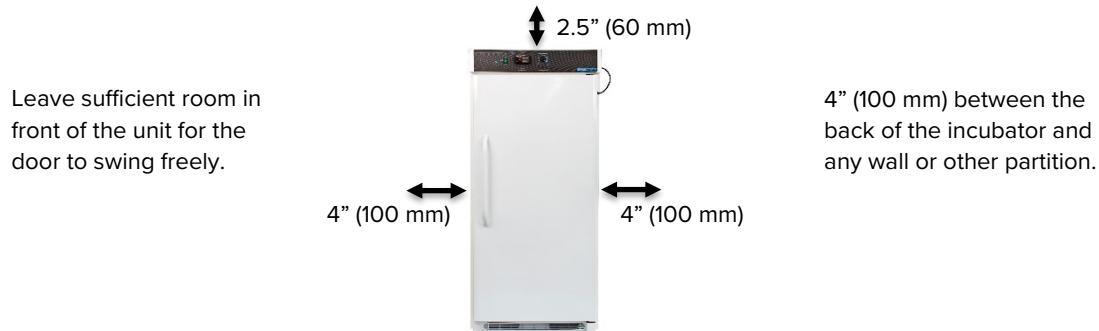

Operating the unit outside these conditions may adversely affect its temperature range and stability.

ENVIRONMENTAL DISRUPTION SOURCES

When selecting a location to install the chamber, consider all environmental conditions that can affect the unit temperature performance. For example:

- Proximity to ovens, autoclaves, and any device that produces significant radiant heat
- Heating and cooling ducts, or other sources of fast-moving air currents
- High-traffic areas
- Direct sunlight

POWER SOURCE REQUIREMENTS

When selecting a location for the unit, verify that each of the following requirements is satisfied.

Power Source: The power source must match the voltage and ampere requirements listed on the unit data plate. These units are intended for **115 VAC** 50/60 Hz applications at **9 amps**.

- **Supplied voltage must not vary more than 10% from the data plate rating.** Damage to the unit may result if supplied voltage varies more than 10%.
- Wall power sources must be protective earth grounded.
- Use a separate circuit to prevent loss of product due to overloading or circuit failure.
- The wall power sources must conform to all national and local electrical codes.

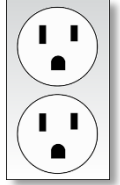

Power Cord: The unit must be positioned so that all end-users can quickly unplug the power cord in the event of an emergency.

- The unit is provided with an integral 125V, 15 Amp, NEMA 5-15P, 8ft (2.5m) power cord.



Circuit Breaker: The unit is provided with an integral circuit breaker to protect against overcurrent conditions.

- Always determine the cause of an overcurrent event before resetting a tripped circuit breaker.

LIFTING AND HANDLING

The unit should only be lifted by its bottom surfaces using proper heavy lifting machinery such as a forklift or pallet jack.

- Handles and knobs are inadequate for lifting or stabilization.
- The unit should be completely restrained from tipping during lifting.
- Transporting the unit while lifted is not recommended and may be hazardous.
- Secure the door in the closed position prior to lifting the unit.
- Do not attempt to move the unit while in operation or before the unit has cooled.

INSTALLATION

INSTALL THE CHAMBER IN LOCATION

Install the unit in a workspace location that meets the criteria discussed in the previous entries of the Installation section.

LEVELING

The unit must be level and stable for safe operation. Ensure that the chamber is placed on a flat and level surface, prior to placing the unit in operation.

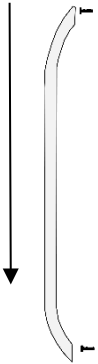

ATTACH THE CHAMBER DOOR HANDLE

Attach provided the door handle to the chamber door.

- Use the instructions packaged with the handle.

INSTALLATION

ADJUST SHELVES

Note: The form factor of the shelves may vary slightly by year of production.

The unit ships with its shelves installed in the incubation chamber. Tape, foam, and other packing dunnage is used to secure the shelves during transit and prevent damage to the chamber interior.

1. Remove all shipping dunnage from the shelving.

Optional: Shelf Adjustment

Move the shelves as needed for your application.



Figure 2: Shelf Installed

DEIONIZED AND DISTILLED WATER

Do not use deionized water to clean the chamber. Use of deionized water may corrode metal surfaces and voids the warranty. Sheldon Manufacturing recommends the use of distilled water in the resistance range of 50K Ohm/cm to 1M Ohm/cm, or a conductivity range of 20.0 uS/cm to 1.0 uS/cm, for cleaning applications.

INSTALLATION CLEANING AND DISINFECTION









If required by your laboratory protocol, clean and disinfect the cultivation chamber and shelving components prior to installation. Cleaning and disinfecting reduce the risk of contamination. The chamber and shelving were cleaned and disinfected at the factory, however, Sheldon Manufacturing cannot guarantee that the chamber was not exposed to contaminants during shipping.

Remove all protective wrappings from shelving components prior to cleaning.

Please see the [Cleaning and Disinfection procedure](#) on page 41 of the User Maintenance section for information on how to clean and disinfect without damaging the chamber and its components.

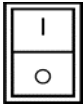
GRAPHIC SYMBOLS

The unit is provided with graphic symbols on its interior and exterior surfaces. These symbols identify hazards, as well as the functions of the adjustable components, and important notes in the user manual.

Symbol	Definition
	Consult the user manual. Consulter le manuel d'utilisation
	Temperature Display Indique l'affichage de la température
	Over Temperature Limit system Indique le système de dépassement de température
	AC Power Repère le courant alternatif
	Indicates I/ON and O/OFF I indique que l'interrupteur est en position marche. O indique que le commutateur est en position d'arrêt.
	Indicates protective earth ground Repère terre électrique
	Adjusts UP and DOWN Ajuster le haut et vers le bas
	Potential Shock Hazard Signale danger électrique
	Recycle the unit. Do not dispose of in a landfill. Indique que l'unité doit être recyclée. Ne pas jeter dans une décharge)

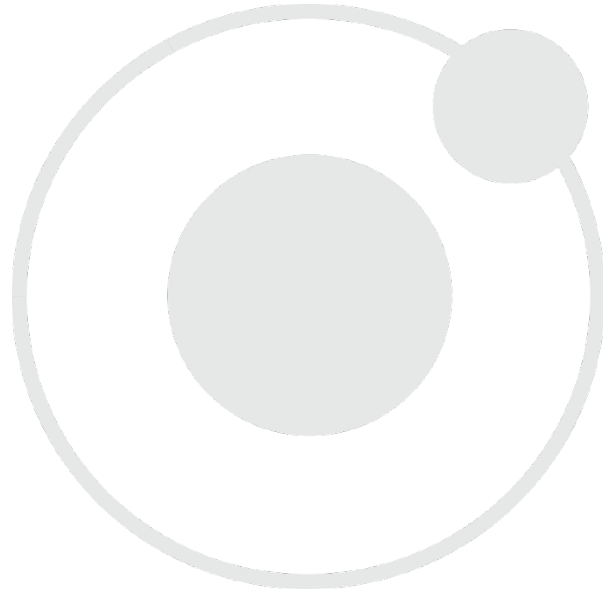

CONTROL PANEL OVERVIEW

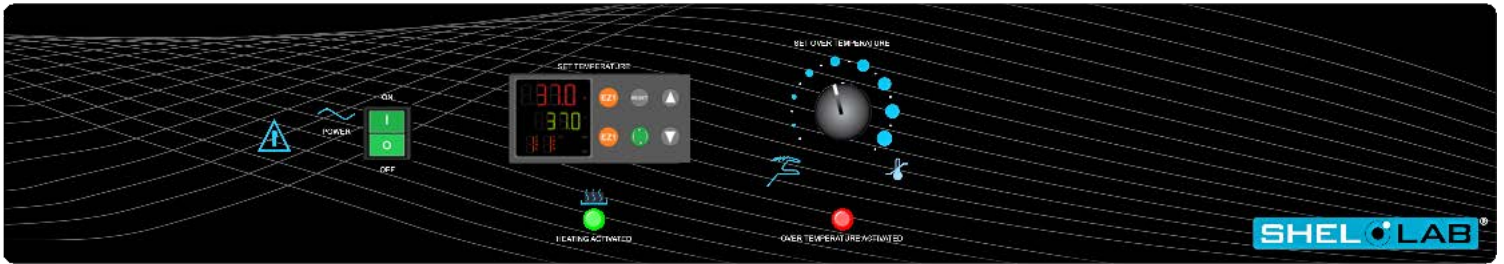

Figure 3: Control Panel

Power Switch

The power switch controls all power to the chamber and its systems. Power is supplied when the switch is illuminated and in the (I) ON position. (O) is the OFF position.



Temperature Controller

The controller arrow buttons are used to adjust the temperature set point, perform calibrations, and adjusting the parameter settings of the Day – Night Cycle.

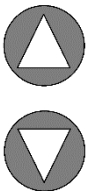

Homepage

Current chamber air temperature in red

Set point in green

“6” indicates night mode

The EZ1 button is used to launch and terminate the Day - Night Cycle of alternating illumination and temperature phases in the cultivation chamber. The EZ2 button does not have a function in the SRI chamber.



The green Advance button is used to scroll forward through Day – Night Cycle pages and to save entered time and temperature parameter values.



The Reset button scrolls the display back to a previous page or menu and also saves currently selected parameter values. Pressing the Reset button repeatedly returns the display to the Homepage.



Note: On some older controllers, the Reset button may be labeled with an infinity ∞ symbol rather than RESET.

CONTROL PANEL OVERVIEW

Display Indicators

A small “1” toward the bottom center of the screen indicates the controller is routing power to the heating element to warm the chamber. During normal operations, this indicator will flicker frequently as the heating element competes with the refrigeration compressor to maintain the set point temperature.

The small “2” illuminates when the fluorescent light bars inside the chamber are powered during the manual day mode or auto cycle day phase.

A small “3” indicates the activation of a relay toggle in the unit that is always active whenever the unit is in its manual day mode.

The small “5” lights up when the manual day mode is active.

A small “6” illuminates when the manual night mode is active.



The red graph icon on the right side of the display illuminates when the day - night auto cycle is active.

Heating Indicator



The green light labeled HEATING ACTIVATED illuminates whenever power is flowing to the heating element. This light will illuminate frequently during normal operations with the door closed, as the heater balances the chilling effect of the refrigeration compressor to achieve a stable and uniform chamber air temperature.

Set Over Temperature



This graduated dial sets the temperature limit for the Over Temperature Limit system. The OTL System operates independently of the main temperature controller and prevents uncontrolled heating of the cultivation chamber in the event the main temperature controller or this sensor fails. For more details, please see the explanation of [the Over Temperature Limit System](#) on page 24 in the Operation Section.

OTL Indicator



The red Over Temperature Activated light illuminates when the Over Temperature Limit system cuts off heating by rerouting power away from the heating element.

OPERATION

THEORY OF OPERATION

The SRI diurnal plant growth chamber is engineered to provide a variable temperature and day – night illumination environment suitable for plant cultivation. The unit can obtain stable, uniform chamber temperatures, ranging from 0° to 40°C.

Achieving and Maintaining the Temperature Set Point

When the SRI21D is powered, its refrigeration compressor runs continuously. The chamber temperature controller is wired to a solid-state temperature probe located in the chamber airstream on the chamber back wall. When the controller detects that the chamber temperature has dropped below the set point, it pulses power to a heating element. The element is located adjacent to the compressor chiller coil in an air recirculation duct at the bottom of the unit.

The processor employs proportional-integral-derivative analytical feedback-loop functions when measuring and controlling the chamber air temperature. PID-controlled heating pulse intensities and lengths are proportional to the difference between the measured chamber temperature and the current set point. The frequency of pulses is derived from the rate of change in that difference. The integral function slows the rate of pulses when the temperature nears the set point to avoid overshooting.

A circulation fan provides even air distribution throughout the chamber, and plays an important role in maintaining temperature uniformity around the shelf space.

Manual Modes and the Day – Night Auto Cycle

The SRI21D comes from the factory set to operate in **manual night mode**, which runs indefinitely with the chamber illumination lights off, and at a steady-state temperature. A small light will turn on inside the chamber, whenever the chamber door is opened. The unit is set to 20°C for manual night mode at the factory, but can be adjusted by the end-user at any time while this mode is active. The unit can also be switched at any time to run in the indefinite **manual day mode** with continual chamber illumination. The day temperature is set to 20°C at the factory but can be adjusted independently of the night temperature, whenever the unit is operating the manual day mode.

The end-user can launch a programmable **Day – Night Auto Cycle mode** with alternating illumination and darkness phases in the cultivation chamber. This indefinite cycle has separate temperature set points for its day and night phases. These set points are independent of the manual mode set points. The SRI21D comes programmed at the factory to start the day phase at 8 AM, Pacific Coast Time (west coast of the United States, UTC -8), and then start the night phase at 8 PM, PCT. The temperature set points for the factory cycle are set to 20°C, for both day and night.



Figure 4: Unit operating in the manual night mode, as indicated by the "6"



Figure 5: Operating in the manual day mode, as indicated by the combination of 2, 3, 5



Figure 6: Operating in the auto cycle day phase, as indicated by the illuminated graph symbol and "2"

End-users can re-program the start times, as well as the temperature set points for both phases. The controller clock can be set to local time. Please see the [Programming the Clock and Day – Night Cycle](#) procedure on page 32.

After the auto – day night cycle is set to launch by the user, it will activate when the chamber clock reaches the start time of the **next** day phase.

Resumption of the Cycle

The chamber Watlow controller is provided with an onboard backup battery with a 2 hour, 45 minute capacity. In the event of a power interruption, this backup allows the chamber to resume the day – night auto cycle, and compensate for any elapsed time by keeping the cycle synched with clock time. The cycle will need to be manually restarted after outages lasting longer than 2 hours, 45 minutes.

The Over Temperature Limit System

When set, the OTL system prevents runaway heating in the event of a failure of the main temperature microprocessor or its sensor probe, by rerouting power away from the heating element. Rerouting takes place whenever the temperature in the cultivation chamber exceeds the OTL setting. The OTL is provided with an independent temperature probe.

The system is set **by the end-user** at approximately 1°C above the current chamber temperature, typically when operating stabilized at the warmest application temperature. This is typically when the unit has been functioning in the day mode or day phase for several hours. Setting the over temperature limit while the unit is operating in the night mode or phase risks tripping the OTL when the unit transitions to a warmer day temperature.

Because of its nature as a cutoff and its lack of PID analytics, the OTL cannot deliver the same degree of temperature stability and measurement precision as the digital display and controls. The OTL System should only be used as a means of heating regulation for the cultivation chamber until a failed processor board and its temperature probe can be repaired or replaced.

PUT THE CHAMBER INTO OPERATION

Perform the following steps and procedures each time the chamber is installed in a new workspace environment. Requires approximately 9 hours.

1. Verify that all the procedures in the Installation section of this manual have been performed.
2. Plug the unit power cord into the workspace supply outlet (power socket).
3. Place the **Power** switch in the ON (I) position.
 - a. The controller display will illuminate and show its home page, with the last programmed temperature set point. The unit comes from the factory set to run in its manual night mode with a set point of 20°C.
4. Set the Over Temperature Limit control dial is in its maximum position. This prevents the OTL system from interfering with setting up temperature operations.
5. Perform the following procedures in the Operation section to finish preparing the chamber:



Set the Day Mode Temperature Set Point page 26

Set the Night Mode Temperature Set Point page 29

Program Clock Times and Auto Cycle Temperature Set Points page 32

Optional: If you are required to verify the accuracy of the chamber temperature display, set up the verification equipment now. See the suggested calibration setup and the first two steps of the suggested calibration procedures on pages 46 - 48 and page 52.



Required: Allow the chamber to operate undisturbed in a manual mode for 8 hours to thermally stabilize before loading samples or calibrating.

Load the Chamber page 38

Optional: Launch the Day – Night Auto Cycle page 39

Set the Over Temperature Limit page 40

OPERATION



Cycle Active

Note: Make sure the day – night auto cycle is not running prior to setting either of the manual mode temperature set points. A red graph symbol will be illuminated on the right side of the controller homepage if the cycle is active. See the instructions below for terminating the cycle.

SET THE MANUAL DAY MODE TEMPERATURE SET POINT

Optional: The indefinite constant temperature manual day mode is set to 20°C at the factory. Change this set point if you will be running the manual day mode at another application temperature.

The chamber comes from the factory set to start in the manual night mode. Perform steps 1 – 8 whenever required to put the unit in the manual day mode.

Put the unit in manual day mode

1. Verify the unit is running the manual night mode before attempting to put it in the day mode. Indicator 6 near the bottom of the screen will be illuminated in the manual night mode.

- If the auto day – night cycle is running, turn it off by pressing the EZ1 button.
- If the unit is already in the manual day mode, skip to step 9 to set the day set point. When in manual day mode the small 2, 3, and 5 indicators near the bottom of the screen will be illuminated.



Night Mode Active, diurnal cycle off.

2. Navigate the operations menu.



BOTH



- a. Press and hold **both the Up and Down Arrow** buttons for approximately 5 seconds.
- The display will change to show the Operation Options menu page.



Operations Menu Page

3. Scroll through the Operations menu to the Parameters option.



- a. Press the **Up Arrow** once.



Parameters Option

Continued on next page

Put the unit in manual day mode (continued)

4. Advance to the Event 1 parameter



x3

- a. Press the green **Advance key** 3 times to reach the parameter.



Event 1 Parameter: Off

5. Change the parameter to ON.



- a. Press the Up Arrow once.
 - This parameter controls the day-illumination lights located in the chamber interior.



Event 1 Parameter: On

6. Save and advance to the Event 2 parameter.



- a. Push the Advance key once.
 - This simultaneously saves the Event 1 parameter and advances to the next parameter. The small, red 2 indicator will illuminate.



Event 2 Parameter: Off

7. Change the Event 2 parameter to On.



- a. Press the Up Arrow once.
 - This parameter toggles a pair of outputs, activating the Day mode.



Event 2 Parameter: On

Continued on next page

OPERATION

Put the unit in manual day mode (continued)

8. Launch the manual day mode and return the display to the homepage.



- a. Press the **Reset key twice** to save the Event 2 parameter as On, launch the day mode, and return to the homepage.



Home Page: Day Mode Active 2, 3, 5

Set the manual day mode temperature

9. On the homepage, while operating in the day mode, adjust the day temperature set point.



- a. Use the Up or Down Arrows to adjust the green set point to that of your cultivation application.



- After the set point is adjusted there may be a pause as the unit controller calculates the optimum heating profile before heating or cooling to the new set point.



Day mode temperature set point adjusted.
Heating to new set point

Note: The manual mode temperature set points use memory slots separate from those of the day - night auto cycle. Changing the manual temperature set points **does not change** the auto cycle set points.

Figure 7: Quick reference chart for placing the unit in manual day mode

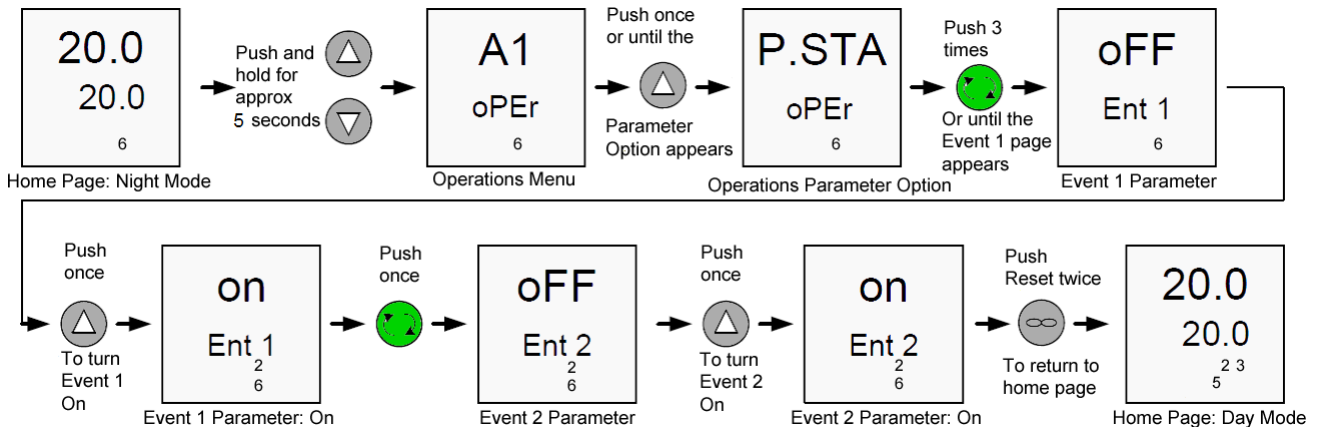

End of procedure

OPERATION

Note: Make sure the day – night auto cycle is not running prior setting the manual mode temperature set points. A red graph symbol will be illuminated on the right side of the controller homepage if the cycle is active.



Cycle Active

SET THE MANUAL NIGHT MODE TEMPERATURE SET POINT

Optional: The indefinite constant temperature manual night mode is set to 20°C at the factory. Change this set point if you will be running the manual night mode at another application temperature.

Perform steps 1 – 8 whenever required to put the unit in the manual night mode.

Put the unit in manual night mode

1. Verify the unit is running the manual day mode before attempting to place it in the night mode. Indicators 2, 3, and 5 will be illuminated in the manual day mode.

- If the auto day – night cycle is running, turn it off by pressing the EZ1 button.
- If the unit is already in the manual night mode, skip to step 9 to set the night set point. When in manual night mode the small “6” indicator near the bottom of the screen will be illuminated.



Manual day mode active, diurnal cycle off.

2. Navigate to the operations menu.



BOTH



- a. Press and hold **both the Up and Down Arrow** buttons for approximately 5 seconds.
- The display will change to show the Operation Options menu page.



Operations Menu Page

3. Scroll through the Operations menu to the Parameters option.



- a. Press the **Up Arrow** once.



Parameters Option

Continued on next page

OPERATION

Put the unit in manual night mode (continued)

4. Advance to the Event 1 parameter.



- a. Press the green **Advance key** 3 times to reach the parameter.



Event 1 Parameter: On

5. Change the parameter to OFF.



- a. Press the Up Arrow once.
 - This parameter controls the chamber day-illumination lights.



Event 1 Parameter: Off

6. Save and advance to the Event 2 parameter.



- a. Press the Advance key once.
 - This simultaneously saves the Event 1 parameter as Off while advancing. The small, red 2 indicator will go dark.



Event 2 Parameter: On

7. Change the Event 2 parameter to Off.



- a. Press the Up Arrow once.
 - This parameter toggles two outputs to turn off the day mode.



Event 2 Parameter: Off

Continued on next page

Put the unit in manual night mode (continued)

8. Launch the manual night mode and return the display to the homepage.



- a. Press the **Reset key twice** to save the Event 2 parameter as Off, launch the night mode, and return to the home page.



Home Page: Night Mode Active Indicator 6

Set the manual night mode temperature set point

9. On the homepage, adjust the temperature set point with the unit operating in the manual night mode.



- a. Use the Up or Down Arrows to adjust the green set point to that of your cultivation application night temperature.



- After the set point is adjusted there may be a pause as the unit controller calculates the optimum profile before cooling or heating to the new set point.



Manual night mode temperature set point adjusted. Cooling to the new set point.

Note: The manual mode temperature set points use memory slots separate from those of the day - night auto cycle. Changing the manual temperature set points **will not change** the auto cycle set points.

Figure 8: Summary quick chart for placing the unit in manual night mode

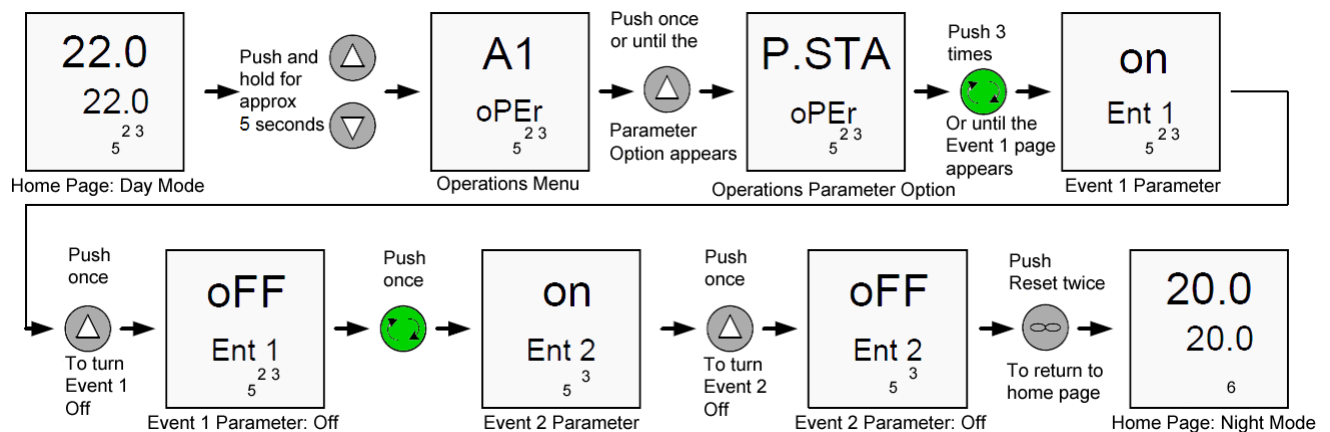

End of procedure

OPERATION

PROGRAM CLOCK TIMES AND CYCLE TEMPERATURE SET POINTS

A **quick reference chart** for this procedure is available at its end on page 37.

Steps 1 – 4 of this procedure set the controller clock to your local time. The clock runs on a 24-hour format. See the table below for examples of 24-hour and am – pm equivalencies.

12-Hour Clock	24-Hour Controller Clock	12-Hour Clock	24-Hour Controller Clock
8:00AM	08:00	2:00PM	14:00
10:00AM	10:00	6:00PM	18:00
12:00PM	12:00	8:00PM	20:00
1:00PM	13:00	12:00AM	00:00

Steps 5 – 17 set the start times and temperature set points for the day and night phases of the auto illumination and temperature cycle.



Skipping steps: If do not wish to change a time setting or temperature set point, do not use the arrow keys to change the setting. Instead, press the Advance key to scroll through a step without adjusting it.



Go back a step: To go back to the start of this procedure, press the Reset button once. Pressing the button twice at any point will return to the Home page.

Setting the chamber clock to local time

1. Starting on the home page, scroll to the current clock time hour page.



- a. Press the **Advance button** once.
 - “hoU1” is the clock hour memory slot (set to 1 pm or 13:00 in this example).



Initial Clock Time Hour

Note: The controller display example to the right will show an adjustment from 1:34 pm to 9:45 am.

2. Set the clock time hour.



- a. Use the **Arrow keys** to adjust to the hour to the current local hour (9 am in this example).



Adjusted Clock Time Hour

Procedure continued on next page

OPERATION

Setting the chamber clock to local time

3. Save the hour and scroll to current clock time minute page.



- a. Press the **Advance button** once to both save the hour setting and advance to the minute page.
 - “Mi1” is the clock minute.



Initial Clock Time Minute Setting

4. Set the clock minute.



- a. Use the **Up and Down arrow** keys adjust the clock minute to the current local minute (45 minutes in this example).



Adjusted Clock Time Minute

5. Save the clock minute setting and scroll to the **day phase start hour**.



- a. Press the **Advance button** once to both save the clock setting and advance to the start of the auto cycle day phase.
 - “hoU2” is the start hour of the day cycle.
 - **Optional.** If you do not wish to adjust the day - night cycle settings, press the Reset button repeatedly to return to the home page **after** having completed Step 5a.



Initial Day Phase Start Hour

Day phase parameters

6. Set the day phase start hour.



- a. Use the **Arrow keys** to adjust the start hour for the day phase.

Note: The next controller display example to the right will show an adjustment of the start times for the day and night phases from 8 am and 8 pm to 7:30 am and 9:30 pm This provides 14 hours of day phase illumination and temperature, and 10 hours of night darkness and temperature.



Adjusted Day Phase Start Hour

Procedure continued on next page

OPERATION

Programming the day phase parameters

7. Save the day phase start hour and scroll to the day phase start minute page.



- a. Press the **Advance button** once to save the hour setting and advance to the minute page.
 - “Mi2” is the day phase start minute.



Initial Day Phase Start Minute

8. Set the day phase start minute.



- a. Use the **Up** and **Down Arrow** keys adjust the day minute (30 minutes in this example).



Adjusted Day Phase Start Minute

9. Save the day start minute setting and scroll to the day phase temperature set point.



- a. Press the **Advance button** once to save the minute setting and advance to the day temperature set point page.
 - “t.SP3” indicates that this is a temperature set point page reserved for the day.



Initial Day Phase Temp. Set Point

10. Set the day phase temperature set point.



- a. Use the **Arrow keys** to adjust to the day set point.



Adjusted Day Phase Temp. Set Point

Procedure continued on next page

OPERATION

Programming the day phase parameters

11. Save the Day Phase set point and scroll to the **night phase** start hour page.



- a. Press the **Advance button** once to save the day set point setting **and** advance to the night hour page.
- “hoU4” is the night start hour. (8 pm or 20:00 in the example to the right).



Initial Night Phase Start Hour

Night phase parameters

12. Set the night phase start hour.



- a. Use the **Up and Down arrow keys** to adjust the night start hour.



Adjusted Night Phase Start Hour

13. Save the night start hour setting and scroll to the night phase start minute.



- a. Press the **Advance button** once to save the hour setting and advance to the night minute page.
- “Mi4” indicates the night start minute page.



Initial Night Phase Start Minute

14. Set the night phase start minute.



- a. Use the **Arrow keys** to adjust to the night minute.



Adjusted Night Phase Start Minute

Procedure continued on next page

Programming the Cycle Night Phase Parameters

15. Save the night start minute and scroll to the night phase temperature set point page.



- a. Press the **Advance button** once to save the start minute setting **and** advance to the night temperature set point.
- “T.SP5” indicates the night temperature set point.



Initial Night Phase Temp. Set Point

16. Optional: Adjust the night phase temperature set point.



- a. Use the **Up and Down arrow keys** to adjust the set point.
- In the display examples to the right, the chamber now has a day phase temperature set point of 21°C and a night phase set point adjusted to 19°C.



Adjusted Night Phase Temp. Set Point

17. Save the night phase set point return to the home page.



- a. Press the **Advance button** once to save the temperature set point at the currently displayed value and return to the home Page.



Home Page

The Day – Night Cycle can now be launched by pressing the EZ1 button. Please see the [Launching the Day - Night Cycle](#) procedure and explanations on page 39. **Do not launch the cycle at this time** if preparing the chamber for use.



OPERATION

Quick Summary: Programing the Current Clock Time and Auto Cycle Parameters

hoU1: Clock Hour
 Mi1: Clock Minute
 hoU2: Day Phase Start Hour
 Mi2: Day Phase Start Minute

t.SP3: Day Phase Set Point
 hoU4: Night Phase Start Hour
 Mi4: Night Phase Start Minute
 t.SP5: Night Phase Set Point

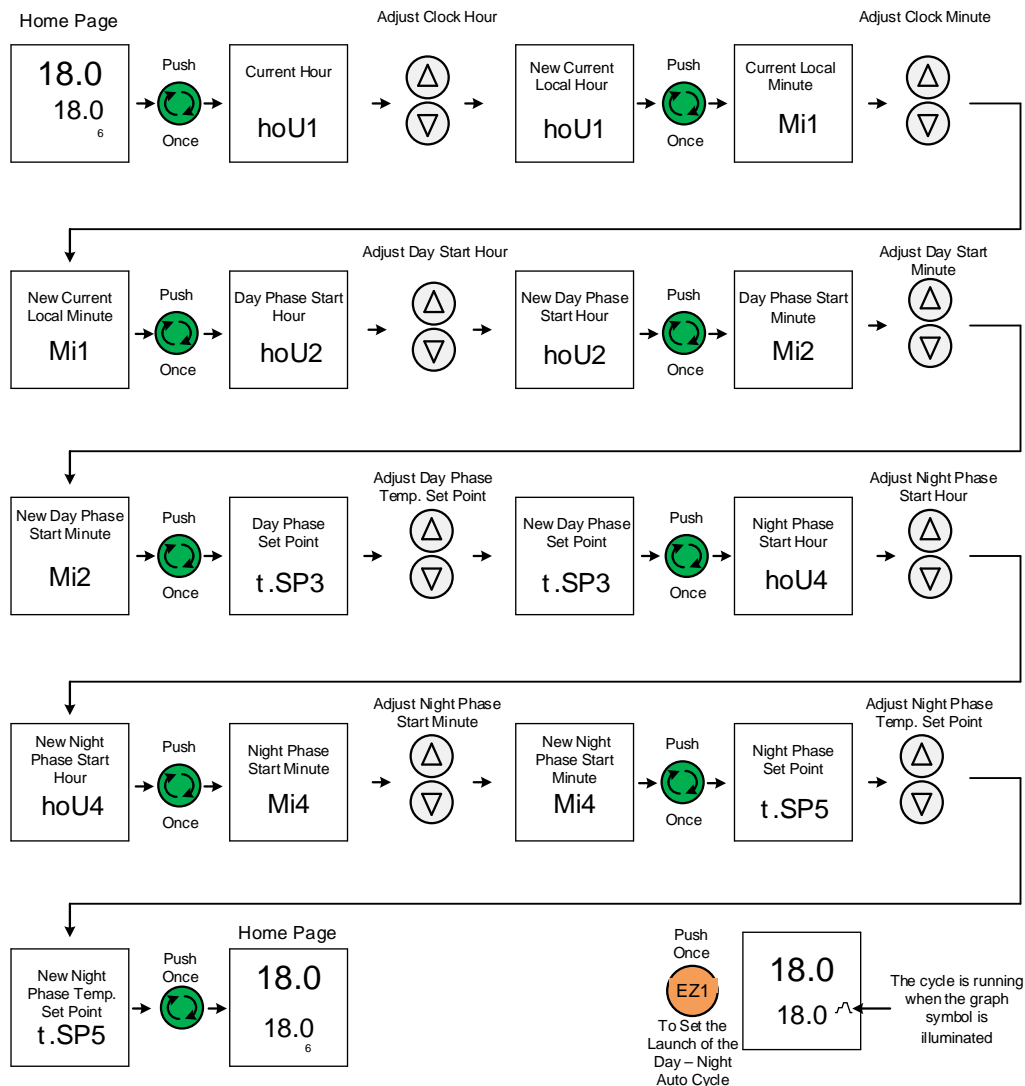

Figure 9: Time and Cycle Temperature Programming

End of procedure

LOAD THE CHAMBER

The manufacturer strongly recommends waiting at least 8 hours after placing the chamber in operation before loading samples in the chamber. This safeguards samples against temperature instability. The samples should be placed at least 1 inch (25 mm) away from the chamber walls. Good spacing allows for maximum air circulation and a higher degree of temperature uniformity.

CONDENSATION AND THE DEW POINT

Relative humidity inside the cultivation chamber should never be allowed to exceed 80% at 25°C.

Exceeding this threshold will likely result in condensation, possible leaks around the chamber, and may cause corrosion damage if allowed to continue for any significant length of time.

Condensation takes place whenever the humidity level in the cultivation chamber reaches the dew point. The dew point is the level of humidity at which the air cannot hold more water vapor. The warmer the air, the more water vapor it can hold.

As the level of humidity rises in a cultivation chamber, condensate will first appear on surfaces that are cooler than the air temperature. Near the dew point, condensate forms on any item or exposed surface even slightly cooler than the air. When the dew point is reached, condensate forms on nearly all exposed surfaces.

Managing condensation primarily depends on either lowering the humidity level or increasing the air temperature in the cultivation chamber.

Note: Rising or falling air pressure from the weather will adjust the dew point up and down in small increments. If the relative humidity in the incubation chamber is already near the dew point, barometric fluctuations may push it across the dew point threshold.

Note: Thin air at higher altitudes holds less humidity than the denser air found at or near sea level.

If excessive condensate has appeared in the cultivation chamber, dry the chamber interior and check the following.

- Make sure samples on the shelves are evenly spaced to allow for good airflow.
- Ensure the chamber door is closing and latching properly.
- Are frequent or lengthy chamber door openings causing significant temperature disruptions and chilling the chamber surfaces? If so, reduce the number of openings.
- Are there too many open or “breathable” containers of evaporating sample media in the chamber? If so, reduce the number of open sample containers.
- Does the ambient humidity in the room exceed the stated operating range of 80% relative environmental humidity? If so, lower the room humidity.
- Is the chamber exposed to an external flow of cold air such as an air-conditioning vent or a door to a cooler hallway or adjacent room? Block or divert the air, or reposition the unit.
- Check the door gasket for damage, wear, or signs of brittleness or dryness. Arrange for replacement of the gasket if damaged or excessively worn.

OPERATION

Note: The auto day – night cycle will not launch until the start time of the next day phase is reached.

LAUNCHING THE DAY - NIGHT CYCLE

Carryout the following steps to set the Day – Night Cycle to launch:

1. Press and briefly hold the EZ1 button.
 - After a brief pause, a red graph icon will illuminate on the right side of the controller home page.
 - **The controller will wait until the start of the next Day Phase** to adjust the lighting and temperature of the cultivation chamber.
 - The cycle will run until terminated by an end user.



Figure 10: Home Page
Cycle operating in the day phase
The 2 indicates that the day illumination lights are active

To terminate the Cycle, briefly press and hold the EZ1 button. After a short pause, the red graph icon will turn off. The Cycle has now ended.



ACCESSORY COMPATIBILITY AND POWER OUTLET

The SRI21D is provided with a 115 voltage, 1 amp power outlet inside the chamber. Do not attach powered equipment that draws more than 1 amp.

Verify that any powered accessory equipment used inside the chamber can safely and effectively operate within your selected temperature range. Powered equipment types such as stirrers or shakers, can generate heat sufficient to disrupt the thermal uniformity and stability of the chamber.

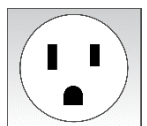

OPERATION

Note: Test the OTL system at least once per year for functionality.

SET THE OVER TEMPERATURE LIMIT

The chamber must be operating at your incubation application temperature and must be stable for at least 1 hour prior to setting the OTL. Set the OTL when the unit is running stable at the hottest temperature of your application. Failure to do so can result in the OTL cutting off chamber heating after the unit transitions from night to day mode or day phase.

1. Set OTL control to its maximum setting, if not already set to max.

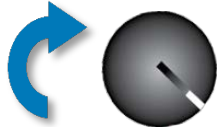

2. Turn the dial counterclockwise until the red Over Temperature Limit Light illuminates.



3. Slowly turn the dial clockwise until the OTL Activated light turns off.



- The Over Temperature Limit is now set approximately 1°C above the current incubator air temperature.

4. Leave the OTL dial set just above the activation point.



Optional: Turn the dial slightly to the left.



- This sets the OTL cutoff threshold nearer to the current incubator air temperature.

If the OTL is sporadically activating, you may turn the dial very slightly to the right (clockwise).

If the OTL continues activating, check for ambient sources of heat or cold that may be adversely impacting the unit temperature stability. Check if any powered accessories in the workspace chamber are generating heat. If you can find no sources of external or internal temperature fluctuations, contact Tech Support or your distributor for assistance.

End of procedure

USER MAINTENANCE

Warning: Prior to any maintenance or cleaning of this unit, disconnect the power cord from the power supply.

Avertissement: Avant tout entretien ou nettoyage de cet appareil, débranchez le cordon d'alimentation de l'alimentation.



CLEANING AND DISINFECTING

If a **hazardous material or substance** has spilled in the unit, immediately initiate your site Hazardous Material Spill Containment protocol. Contact your local Site Safety Officer and follow instructions per the site policy and procedures.

- The unit chamber should be cleaned and disinfected prior to first use.
- Periodic cleaning and disinfection are required to prevent microbiological contamination.
- Do not use spray-on cleaners or disinfectants. These can leak through openings and coat electrical components.
- Do not use cleaners or disinfectants that contain solvents capable of harming paint coatings, acrylic glass, or stainless steel surfaces. **Do not use chlorine-based bleaches or abrasives—these will damage the chamber liner.**
- Consult with the manufacturer or their agent if you have any doubts about the compatibility of decontamination or cleaning agents with the parts of the equipment or with material contained in it.

Warning: Exercise caution if cleaning the unit with alcohol or flammable cleaners. Always allow the unit to cool down to room temperature prior to cleaning and make sure all cleaning agents have evaporated or otherwise been completely removed prior to putting the unit back into service.

Avertissement: Soyez prudent lorsque vous nettoyez l'appareil avec de l'alcool ou des produits de nettoyage inflammables. Laissez toujours refroidir l'appareil à la température ambiante avant le nettoyage et assurez-vous que tous les produits de nettoyage se sont évaporés ou ont été complètement enlevés avant de remettre l'appareil en service.



Cleaning

1. Disconnect the unit from its power supply.
2. Remove all removable interior components such as shelving and accessories.
3. Clean the unit with a mild soap and water solution, including all corners.
 - **Do not use an abrasive cleaner**, these will damage metal surfaces.
 - **Do not use deionized water to rinse or clean with.**
 - Take special care when cleaning around the temperature sensor probes in the chamber to prevent damage. Do not clean the probes.
4. Rinse with distilled water and wipe dry with a soft cloth.

USER MAINTENANCE

Disinfecting

Keep the following points in mind when carrying out your laboratory, clinical, or production space disinfection protocol:

- Turn off the unit to safeguard against electrical shocks.
- Disinfect the unit using commercially available disinfectants that are non-corrosive, non-abrasive, and suitable for use on plastic and painted surfaces. Contact your local Site Safety Officer for detailed information on the disinfectants compatible with your cultivation or culturing applications.
- Chlorines, quaternary ammonias, and other overtly volatile disinfecting agents will evaporate into the chamber environment. Concentration in the chamber atmosphere will increase over time, potentially leading to inhibited growth or metabolic symptoms in sample populations.
- If possible, remove all interior accessories (shelves, Petri dish racks, and other non-attached items) from the chamber when disinfecting.
- Disinfect all corners of the chamber.
- After completion of your institutional protocol, allow all disinfectants to evaporate completely.

MINIMIZING CONTAMINATION EXPOSURE

The following are suggestions for minimizing exposure of the cultivation chamber to potential contaminants.

- Maintain a high air quality in the laboratory workspaces around the chamber.
- Avoid placing the unit near sources of air movement such as doors, air vents, or high traffic routes in the workspace.
- Minimize the number of times the chamber door is opened during normal operations.
- Periodically, inspect the door latch, trim, catch, and gaskets for signs of deterioration.

ELECTRICAL COMPONENTS

Electrical components do not require maintenance. If the chamber fails to operate as specified, please contact your distributor or [Sheldon Technical Support](#) for assistance (please see page 6).

REFRIGERATION AND DEFROSTING

The refrigeration compressors of most home refrigerators run periodically in order to maintain an average chamber temperature centered on the thermostat setting. This results in temperature oscillations of up to 2° or 3°C and reflects the fact that affordable refrigeration compressors cannot provide the high degree of temperature stability needed for laboratory applications — at least not without assistance.

To counteract this instability, refrigeration compressors in the SRI family of incubators and plant growth chambers run continually to provide constant chilling. At the same time, precise applications of heat maintain thermal stability in the incubation or cultivation chamber to approximately $\pm 0.5^{\circ}\text{C}$.

Freezing and Defrosting

Air is chilled in the chamber by blowing over a refrigeration coil. The surface temperature of the coil may dip below freezing. This happens frequently when the unit is run toward the cold end of its performance range. At these temperatures, humidity in the air will condense and freeze on the coil.

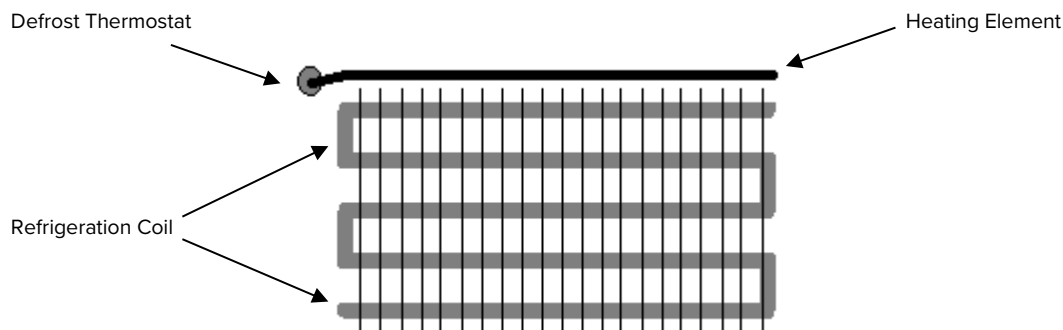

Figure 11: Refrigeration Coil and Heating Element

To counteract this, a defrost thermostat that checks the temperature of the coils for 20 minutes, once every 12 hours. If the coil surface temperature is cool enough for ice to form during the 20-minute interval, the defrost thermostat deactivates the compressor. This allows heat from the nearby heating element to melt the ice on the coil without having to compete with the chilling flow of coolant fluid through the coil. The defrost thermostat reactivates the compressor when the surface temperature rises above the defrost trigger set point or when the 20-minute interval comes to an end.

If the incubator is running at the low end of its temperature range, defrosting can result in short-lived but significant heat spikes in the unit incubator. This may preclude its use in biological oxygen demand studies below 20°C.

Factors in Ice Build Up

Incubators and diurnal chambers used for biologic oxygen demand studies and other closed-container applications will generally require infrequent and very short defrost runtimes. However, runtimes may be prolonged and occur more frequently if the incubator is used in a high humidity environment with the door opened several times a day or left open for prolonged periods. Units with open media containers, water pans, and other sources of evaporating water in the incubation chamber may also experience significant ice buildup. This will necessitate long runs of the auto defrost cycle twice a day. If the humidity is high enough and the temperature is set toward the low end of the unit performance range, humidity can overwhelm the defrosting cycle, and significant ice accumulation may occur on the coil.

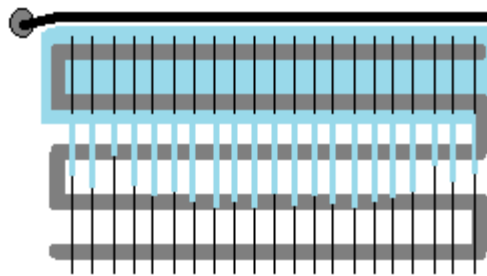

Figure 12: Ice on the Cooling Coil

Loss of Efficiency

As ice accumulates, it insulates the heat-transporting coolant fluid within the coil, driving an increasing loss of chilling efficiency. This may even cause false high temperature readings on the defrost thermostat and prevent the system from recognizing that a defrost run is needed. When this occurs, the first sign of trouble is often a rise in the chamber temperature, even though the main control temperature set point has not been changed.

Units with heavy accumulations of ice on the cooling coil must be manually defrosted by shutting down the unit for a 24-hour period. This provides sufficient time for the ice to melt. See the next page for manually defrosting the chamber.

Forcing the Defrost Cycle

For units that are icing up from high humidity and low temperature settings, Sheldon Manufacturing offers a defrosting system retrofit kit that replaces the defrost thermostat installed at the factory. The retrofit kit automatically turns off the compressor for ten minutes every twelve hours, regardless of the temperature on the coil surface. Please see the SHELL LAB website for pricing or contact Sheldon Technical Support if you have any questions. Part Number 9900577.

Turning Off the Automatic Defrost

Deactivating the defrost thermostat will result in ice accumulation and a gradual loss of cooling efficiency. Incubators used for BOD and other closed-container applications with the defrost thermostat turned off will likely require manual defrosting every 6 months. Units with open sources of water evaporation and the defrost thermostat shut off will require manual defrosting every 2 to 3 months. The exact interval depends on the environmental humidity, temperature setting, and the amount of evaporation taking place inside the incubation chamber.



Figure 13: Defrost Cycle Switch – Top Left of Unit, Back side

Manual Defrosting

Carryout the following steps to manually defrost the unit:

1. Unplug the incubator, open the chamber door, and allow the unit to stand undisturbed with the door open for 24 hours.
2. Wipe up any condensate that forms in the chamber as well as any water around the incubator after 24 hours have elapsed.
3. Close the chamber door, plug the incubator power cord into the wall power source, and place the unit back into operation.

The Low Set Limit Dial (Avoiding Freezing Temps)

The chamber comes with a low set limit system control, set at the factory to turn off the refrigeration compressor when the incubator air temperature falls to just above 0°C. This is intended to prevent the incubator from reaching or falling below the freezing point. Freezing and sub-freezing temperatures risk damaging plant samples and as well as fluid-filled BOD sample containers.

Under most circumstances, the low set limit system should not be adjusted. If you wish to adjust the limit setting, please contact [Technical Support](#) (page 6). **The manufacturing defect warranty does not cover damage** to the unit or samples by freezing or subfreezing temperatures if the low set limit has been set to 0°C or lower than 0°C. The unit is not intended to be operated at freezing or sub-freezing temperatures.



Figure 14: Low Set Limit Dial (Bottom Left of Unit, Back)

USER MAINTENANCE

Note: Performing a temperature display calibration requires a temperature reference device. Please see the [Reference Sensor Devices entry](#) on page **Error! Bookmark not defined.** for device requirements.

Temperature calibrations are performed to match the chamber temperature display to the actual air temperature in the incubation chamber. The actual air temperature is supplied by a calibrated reference device. Calibrations compensate for long-term drifts in the microprocessor controller as well as those caused by the natural material evolution of the sensor probe in the heated and chilled incubation space. Calibrate as often as required by your laboratory or production protocol, or regulatory compliance schedule. Always calibrate to the standards and use the calibration setup required by your industry requirements or laboratory protocol.

A **quick reference card** for the calibration procedure steps can be found on page 57.

Suggested Single Point Offset Calibration Setup

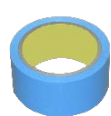

**Heat-resistant
non-stick tape
recommended**

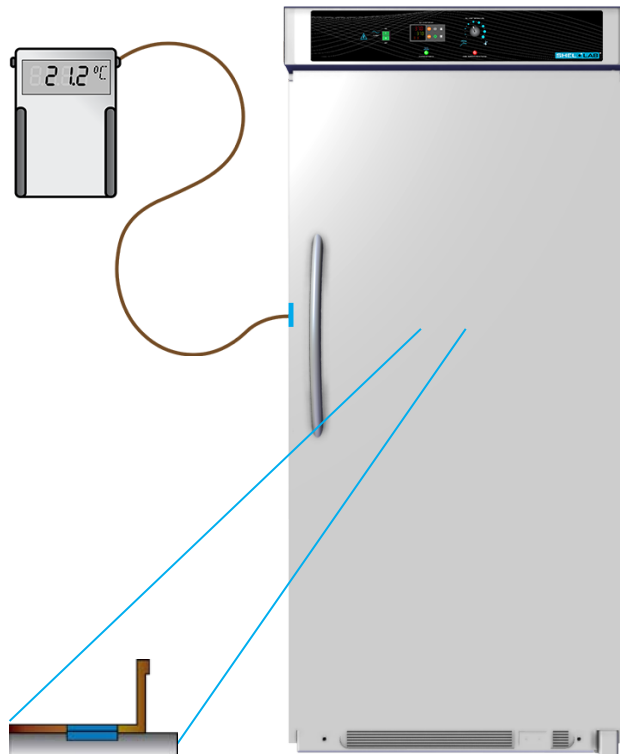

3) The incubator chamber door must be closed and latched. Use the tape to seal any exterior gaps caused by the probe wires.

4) Place the Defrost switch on the back of the unit in the “O” Off position for the duration of the calibration procedure. The defrost cycle can impact the chamber temperature sufficient to result in an inaccurate calibration.



2) Place the sensor probes inside the cultivation chamber with the probe heads at least at least 2 inches (50 mm) from the surface of the shelving or walls to prevent heatsinking. Secure with non-stick, heat-resistant tape.

If you are using only one thermocouple, place the sensor probe head as close to the geometric center of the chamber as possible.

1) Introduce the reference device thermocouple sensor probes through the chamber door space. The door must close and latch fully.

USER MAINTENANCE

Temperature Stabilization

The chamber air temperature must stabilize in order to perform an accurate calibration. Additionally, the unit must be calibrated twice — once at your application day temperature and then at your application night temperature to compensate for the extra heat generated during the day mode by the day illumination bulbs in the chamber. Calibrate twice, even if the day and night temperatures of your study are the same.

The calibrations must be carried out with the unit running in its manual mode. Accurate calibrations cannot be carried out while the auto cycle is running. Calibrating in the manual day and night modes will also calibrate for the auto cycle day and night phases.

1. After introducing and placing the temperature probes, place the unit into manual day mode (page 26, steps 1 - 8). The day temperature set point should be that of your application day period.
 - o This is the day temperature you will be running the unit at during your study, regardless if it will be operating in the auto cycle phases or a manual mode.
2. Allow the unit to operate undisturbed for **8 hours** in the manual mode at your application day temperature—for example overnight—before starting the calibration when first putting the unit into operation in a new environment.
 - o To be considered stabilized the unit must operate at your day calibration temperature with **no fluctuations of $\pm 0.5^{\circ}\text{C}$ or greater**.
3. See next page for a suggested calibration procedure.

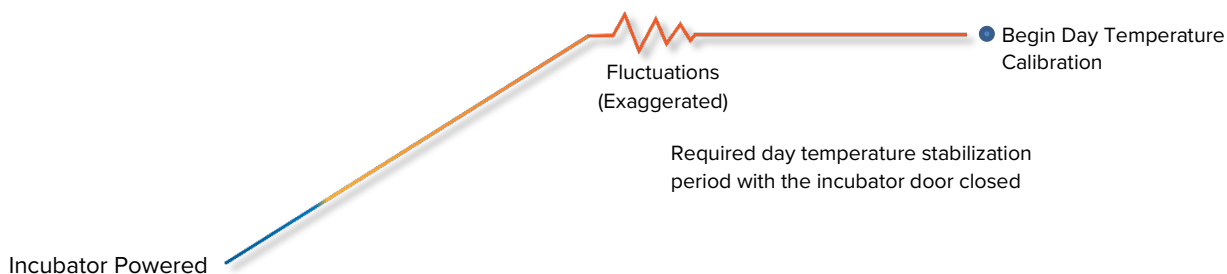

Night Temperature Calibration

4. Following a successful day calibration, place the unit in its manual night mode (page 52). The temperature of the manual night mode should be set to night temperature of your application.
5. Allow the unit to operate undisturbed for a **minimum of 2 hours** to achieve and stabilize at the night temperature.
 - o To be considered stabilized the unit must operate at your night calibration temperature for at least 1 hour with **no fluctuations of $\pm 0.5^{\circ}\text{C}$ or greater**.

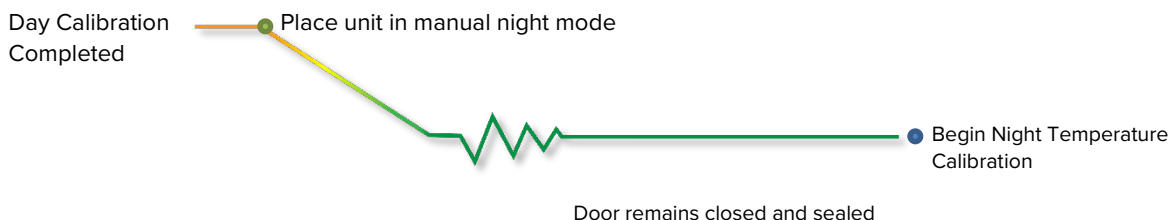

USER MAINTENANCE

Temperature Display Calibration – Day Temperature

1. Once the day temperature has stabilized, compare the reference device temperature reading and the reading of the chamber controller.
 - a. If the readings are the same, or a difference between the two falls within the acceptable range of your protocol, the display is calibrated for day temperature. **Advance to the Calibrating the Night Temperature steps starting on page 52.**

- OR -

- b. If a difference falls outside your protocol range, advance to the next step.

Reference Device



Reference Device

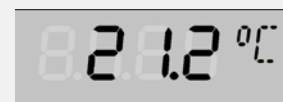

2. A display calibration offset must be entered to match the current display value to the reference device reading.

3. Determine the offset value and write down for use in Step 5.
 - The offset value is the difference between the reference device reading and the reading of the chamber controller temperature display.

Reference Sensor Reading	Controller Display	Offset Value
23.0°C	22.0°C	1.0
21.2°C	22.0°C	-0.8

Reference Device

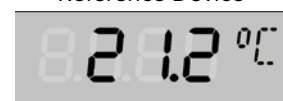

Offset Value: -0.8

4. Navigate to the Operations menu page.



- a. Push and hold **both** the Up and Down Arrow Button simultaneously for approximately 5 seconds.

Note: Holding down both arrows for 10 seconds will open a Set menu for setting memory parameters. If this happens, press the Reset button to return to the Home page, then begin this step again.



Operations Menu

Continued on next page

USER MAINTENANCE

Calibrating for Day Temperature (Continued)

5. Scroll to the Calibration Offset option.



- a. Press the green Advance button 3 times until “i.CA” appears in the green middle display line.



Current Offset 0

6. Enter the current calibration offset.



- a. Use the Up and Down arrow keys to enter the offset in the red numerical display line.



Current Offset -0.8

7. Once the offset is entered, push the Reset Button (∞) twice.



- The first push exits the Operation Options menu and saves the offset in the controller short-term memory.
- The second push returns the display to the Home Page, which will now show a display value corrected with the offset to match the reference device reading.
- The chamber will heat or chill to match the set point with the corrected display value.



Chamber heating to achieve the set point with the corrected display value

8. Once the chamber has achieved the set point temperature, wait at least 1 hour for the chamber to stabilize.

- Failure to wait until the cultivation chamber is fully stabilized will result in an inaccurate calibration.



Wait 1 Hour

Continued on next page

USER MAINTENANCE

Calibrating for Day Temperature (Continued)

9. Compare the reference device reading with the chamber temperature display again.
 - a. If the reference device and the chamber temperature display readings are the same or the difference falls within the range of your protocol, the chamber is now calibrated for day temperature. **Advance to the Saving the Day Calibration steps** starting on page 51.

- Or -

- b. See the next step if the readings fail to match or fall outside of your protocol range.

Reference Device



Chamber Display



10. If a difference still falls outside the acceptable range of your protocol, repeat steps 3 – 11, up to two more times.
 - Three calibration attempts may be required to successfully calibrate units that are more than $\pm 2^{\circ}\text{C}$ out of calibration.
 - If the temperature readings of the display and the reference device are still not close enough to be acceptable by your laboratory protocol after three calibration attempts, contact your distributor or technical support for assistance.

Reference Device

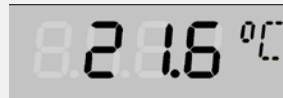

Chamber Display



Saving the Day Calibration

Once the display reading matches the reference device, the current offset must be saved in the day temperature calibration memory slot or it will be lost the next time the chamber is turned off.

Procedure continued on next page

USER MAINTENANCE

Saving the Day Calibration (Continued)

11. Jump to the Memory Management menu page.

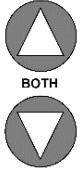

- a. Push and hold **both** the Up and Down Arrow Button simultaneously for 10 seconds.
- b. The display will advance to the Operations page after approximately 5 seconds, then to the Memory Management (Set) page after another five seconds.



Settings Menu Page

12. Advance to the Global Memory Parameter list.



- a. Press the Up arrow button 3 times.



Global Parameters List

13. Scroll to the Calibration Memory parameter.



- a. Press the **green Advance button** 15 times.



Temperature Slot Parameters

14. Select the Day Temperature Calibration "Set 2" Memory slot.



- a. Press the **Down Arrow button** 1 time.



Day Cal. Memory Slot

Procedure continued on next page

USER MAINTENANCE

Saving the Day Calibration (Continued)

15. Save the current calibration value in the memory slot and return to the home page by pressing the Reset Button (∞) twice.
 - The first Reset Button press saves the current calibration value in the presently selected memory slot (Set 2).
 - The second button press scrolls the display back to the Home page.



Home Page

Night Temperature Calibration

1. Place the unit in the manual night mode. Please see the [Setting Manual Night Mode Temperature Procedure](#), and use steps 1 – 8 starting on page 29.



Home Page: Night Mode Active, 6

2. Once the unit is in night manual mode, allow the chamber to operate for 2 hours undisturbed, with the door closed. This allows the unit to achieve temperature stability after the day illumination bulbs in the chamber turn off.
 - The reference device should register no temperature fluctuations of greater than $\pm 0.5^{\circ}\text{C}$ for at least **1 hour** prior to continuing.
 - Failure to wait for stabilization will result in an inaccurate display reading for the night temperature.



Wait 2 Hours

3. Once the temperature has stabilized at the manual Night set point, compare the reference device temperature reading and the reading of the chamber controller.

Reference Device

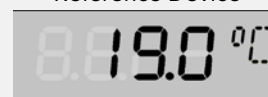

- a. If the readings are the same, or a difference between the two falls within the acceptable range of your protocol, the chamber is calibrated for temperature. **The temperature calibration procedure is now complete.** Return the chamber to normal operations.

- OR -

- b. If a difference falls outside your protocol range, advance to the next step.

Chamber Display



Procedure continued on next page

USER MAINTENANCE

Night Temperature Calibration (Continued)

4. A display calibration offset must be entered to match the current display value to the reference device reading.

Reference Device



5. Determine the offset value and record it for use in three steps.

- The offset value is the difference between the reference device reading and the reading of the chamber controller temperature display.
- The offset value will be used to adjust the controller reading to match the reference device.

Reference Device

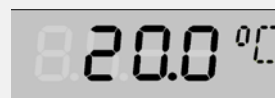

Chamber Display



Matching Offset Value: 1.0

Reference Sensor Reading	Controller Display	Offset Value
20.0°C	19.0°C	1.0
18.0°C	19.0°C	-1.0

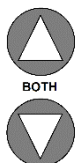

6. Navigate to the Operations menu page.
 - a. Push and hold **both** the Up and Down Arrow buttons simultaneously for approximately 5 seconds until the oPEr menu appears.



Operations Menu

Note: Holding down both arrows for 10 seconds will open a Set menu for setting memory parameters. If this happens, press the Reset button to return to the Home page, then press both Arrow buttons again for 5 seconds.

Procedure continued on next page

USER MAINTENANCE

Night Temperature Calibration (Continued)

7. Scroll to the Calibration Offset option



- a. Press the green Advance button 3 times until “i.CA” appears in the green middle display line.



Current Offset 0

8. Enter the current calibration offset.



- a. Use the Up and Down arrow keys to enter the offset in the red numerical display line.



Current Offset, 1

9. Once the offset is entered, push the Reset Button (∞) twice.



- The first push exits the Operation Options menu and saves the current offset in the controller short-term memory.
- The second push returns the display to the home page, now showing current display value corrected with the offset to match the reference device reading.
- The chamber will now heat or chill to match the set point with the corrected display value.



Chamber cooling to achieve the set point with the corrected display value

10. Once the chamber has achieved the set point temperature, wait at least 1 hour for the chamber to stabilize.

- a. Failure to wait until the cultivation chamber is fully stabilized will result in an inaccurate reading.



Wait 1 Hour

Procedure continued on next page

USER MAINTENANCE

Night Temperature Calibration (Continued)

11. Compare the reference device reading with the chamber temperature display again.
 - a. If the reference device and the chamber temperature display readings are the same or the difference falls within the range of your protocol, **advance to Saving the Night Calibration on page 56.**

- Or -

- b. If the readings fail to match or fall outside your protocol range, advance to the next step.

Reference Device

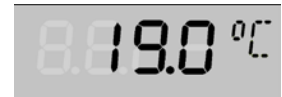

Reference Device



12. Repeat steps 3 – 11 up to two more times for the night phase if the unit is still not calibrated.
 - Three calibration attempts may be required to successfully calibrate units that are more than $\pm 2^{\circ}\text{C}$ out of calibration.
 - If the readings of the current temperature display and the reference device are still not close enough to be acceptable by your laboratory protocol after three calibration attempts, contact your distributor or technical support for assistance.

Saving the Night Calibration

Once the display reading matches the reference device, the current offset must be saved in the night temperature calibration memory slot or it will be lost the next time the chamber is turned off.

Procedure continued on next page

USER MAINTENANCE

Saving the Night Calibration (Continued)

13. Navigate to the Settings Menu page (SEt).

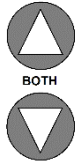

- a. Push and hold **both** the Up and Down Arrow Button simultaneously for 10 seconds.
- The display will advance to the Operations page after approximately 5 seconds, then to the Settings Menu page after another five seconds.



Settings Menu Page

14. Advance to the Global Settings parameter list.



- a. Press the Up arrow button 3 times.



Global Settings List

15. Scroll to the Memory parameter.



- a. Press the **green Advance button** 15 times.



Temperature Slot Parameters

16. Select the night temperature calibration "Set 1" memory slot.



- a. Press the **Up Arrow button** 1 time.

Note: Select the None memory slot if you do not wish to save the current calibration value.



Night Cal. Memory Slot

Procedure continued on next page

USER MAINTENANCE

Saving the Night Calibration (Continued)

- Save the current calibration value in the memory slot and return to the Home Page by pressing the **Reset Button** (∞) twice.



- The first Reset Button press saves the current calibration value in the presently selected calibration long-term memory slot (Set 1).
- The second button press scrolls the display back to the Home Page.



Home Page

- The chamber is now calibrated for temperature. Return the unit to normal operations.

Figure 15: Summary chart for calibrating day temperature

Prior to calibrating, verify that 2, 3, and 5 are illuminated, indicating the unit is in the **manual day mode**.

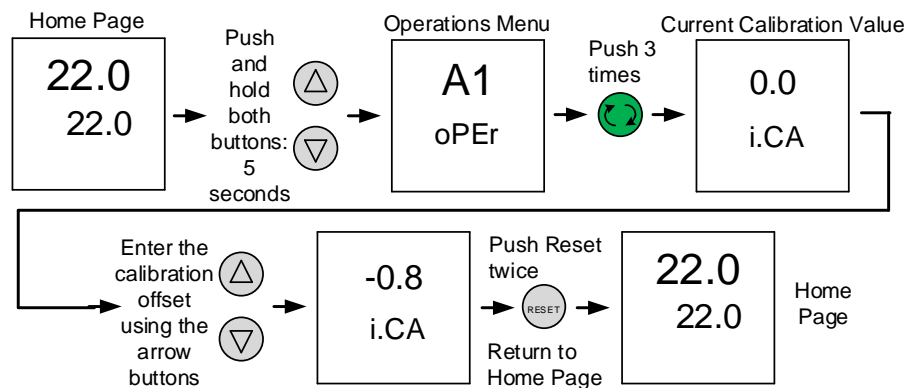

Saving the current calibration value (day temp) in the long-term memory

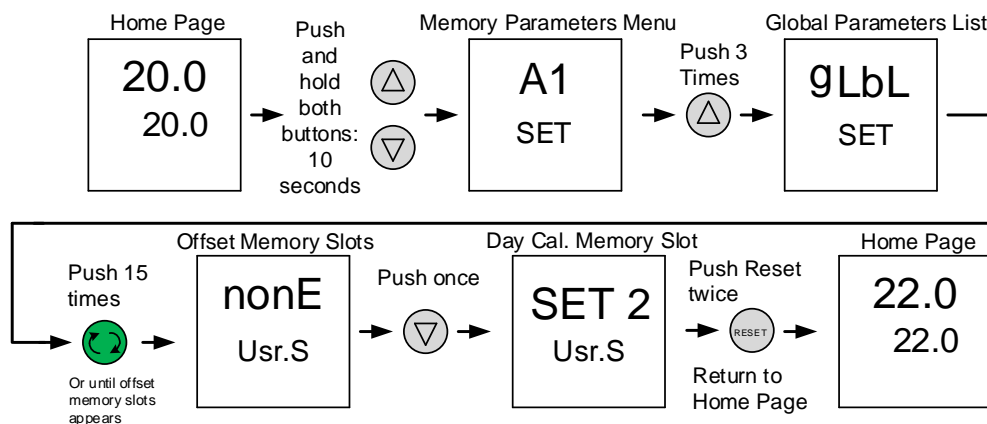

Selecting the Set 2 memory slot and pressing RESET saves the current calibration offset (day temp) in the in the long-term memory

Figure 16: Summary chart for calibrating night temperature

Prior to calibrating, verify that **6** is illuminated, indicating the unit is in the **manual night mode**.

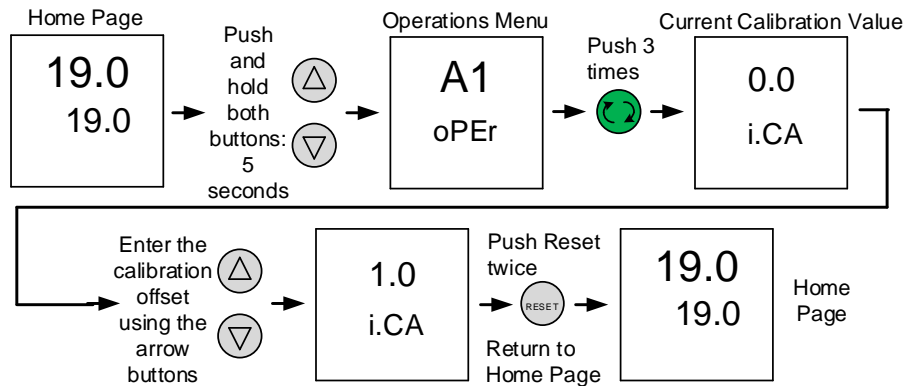

Saving the current calibration value (night temp) in the long-term memory

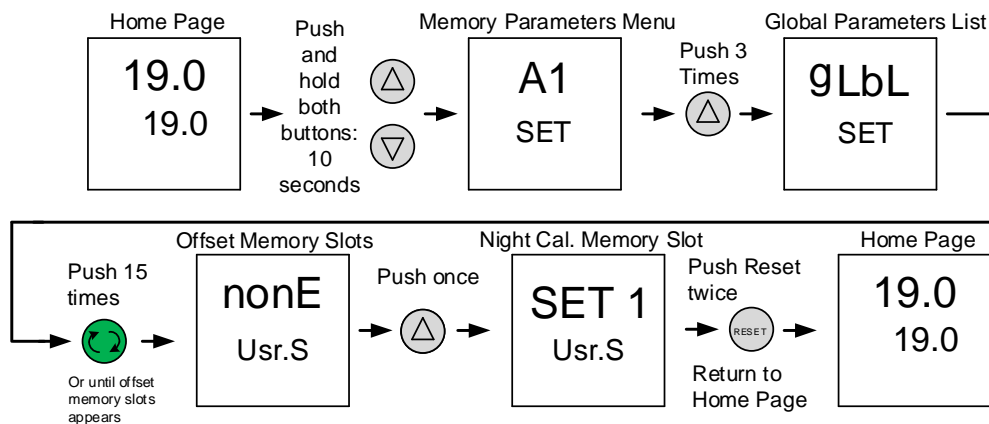

Selecting the Set 1 memory slot and pressing RESET saves the current calibration offset (night) in the in the long-term memory

End of procedure

USER MAINTENANCE

DIAGNOSTICS - TEMPERATURE ISSUES

If the unit is experiencing temperature issues, use the following guide to gather information on the unit, prior to contacting Technical Support. Gathering and sharing this information with Tech Support significantly increases the chance a service technician will be dispatched with the parts needed to fix your unit during their first visit.

Steps

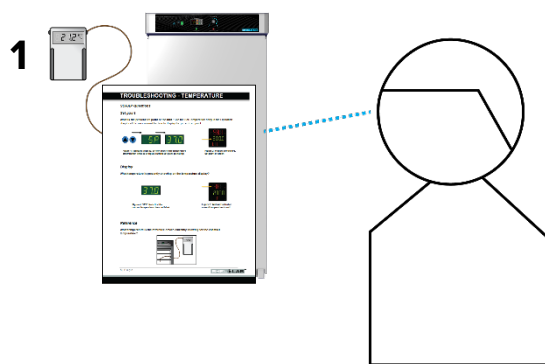

Read the SDRAP diagnostic questions on pages 64 and 65 and observe the unit in operation.

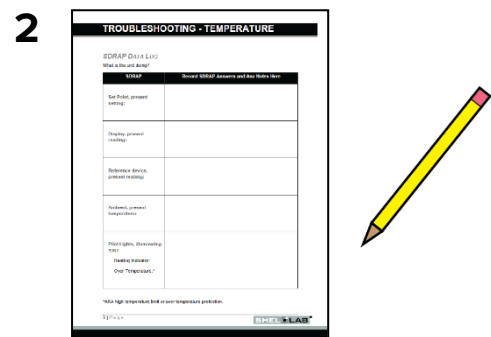

Record the observations in the SDRAP Data Log on page 60.

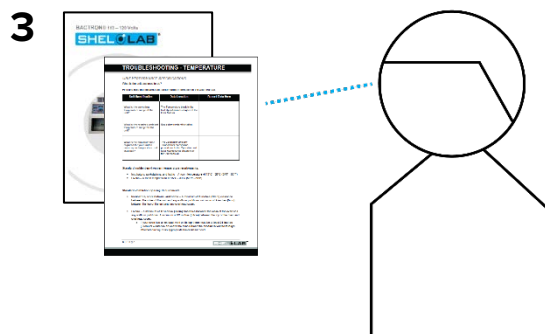

Read the Unit Performance Specification questions on page 61 and consult the user manual for answers.

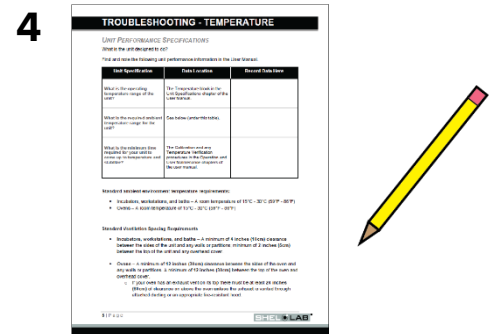

Record the answers in the Unit Specifications Log on page 61.

5 **Share this information with Tech Support!**

USER MAINTENANCE

SDRAP Data Log

What is the unit doing? See pages 64 - 65 for the detailed walkthrough of the SDRAP questions.

SDRAP	Record SDRAP Answers and Any Notes Here
S et Point, present setting:	
D isplay, present Temperature reading:	
R eference device, present reading:	
A mbient, present temperature:	
P ilot Lights, illuminating Y/N?	Heating Indicator:
	Refrigeration compressor running, yes / no?
	Over Temperature Activated:

This page may be copied for institutional use

USER MAINTENANCE

Unit Performance Specifications

What is the unit designed to do?

Find and note the following unit designation and performance information in the user manual.

Unit Specification	Data Location	Record Data Here
Model Type:	The unit data plate lists the model type. Verify you are attempting to diagnose an SRI21D.	
What is the operating temperature range of the unit?	The Temperature block in the Unit Specifications chapter, page 68.	
What is the required ambient temperature range for the unit?	See below (under this table).	
What is the minimum time required for your unit to come up to temperature and stabilize?	Allow a minimum of 4 hours of continual operation for the unit to achieve a stable temperature.	

Standard ambient environment temperature requirements:

- A room temperature of 15°C - 30°C (59°F - 86°F)

Standard Ventilation Spacing Requirements

- A minimum of **4 inches (100 mm)** clearance between the sides of the cultivation chamber and any walls or partitions. A minimum of **25 inches (50 mm)** between the top of the unit and overhead cover.

This page may be copied for institutional use

Required Items

You must have the following items on hand to answer the diagnostic questions.

A temperature reference device – A calibrated digital thermometer with sensor probes. The device must be at least as accurate as the temperature display of your unit.

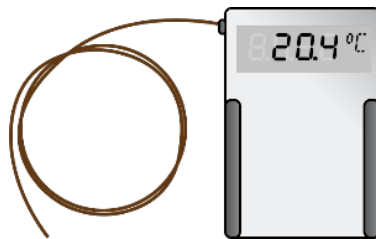

A copy of the user manual for the unit – Must be available in the same room as the unit for use.



USER MAINTENANCE

Note: Does the car actually have gas in the tank? Have you physically verified the computer is plugged in? Yes, we are going to ask some very basic questions. Please bear with us. Methodical verifications and the elimination of assumptions are often the quickest means of getting a unit back into operation.

Before Starting

1. The unit must be connected to a power source that meets the requirements in the Installation chapter (page 15) and turned on.

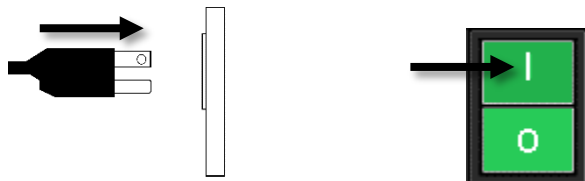

2. A reference temperature device sensor probe must be placed in the chamber.
 - See the probe placement instructions in the [Temperature Calibration procedure](#) on page 46.

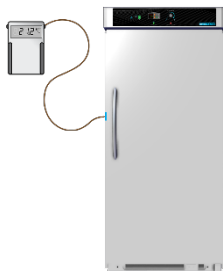

3. The unit must have adequate time to come up to temperature and stabilize. **Failure to wait will result in an inaccurate diagnosis.**



- Allow 4 hours for the unit to achieve its temperature.
- Start the “Diagnostic Data Procedure” **when the allotted time has passed**, even if the unit fails to achieve the set point temperature.

USER MAINTENANCE

Diagnostic Data Procedure – SDRAP Questions

Set point?

What is the present set point of the unit? See the Set Temperature entry in the “Operation” chapter of the user manual for how to display the present set point.



Figure 17: Set Point in Green

Display?

What temperature is presently showing in the chamber temperature display?



Figure 18: Present temperature in red

Reference?

What temperature is the reference device currently showing for the chamber temperature?

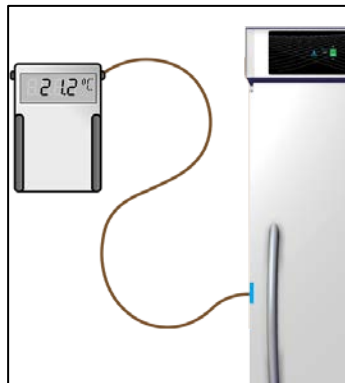

USER MAINTENANCE

Ambient?

What is the room temperature?

- For best results, measure the temperature in the same section of the room where the unit is located. Do not place your thermometer on the unit.

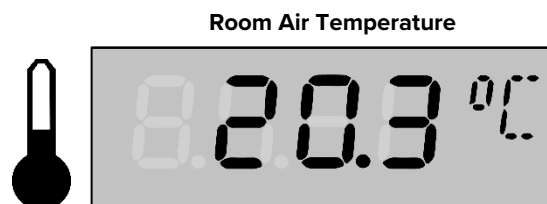

Pilot Lights?

- 1) Is the heating active indicator on the control panel flashing or otherwise illuminating.

Figure 19: Heating Indicator



“1” indicates the controller is calling for power to the element(s)

During normal operations, the “1” indicator should flicker on and off frequently as the heating element competes with the refrigeration compressor to achieve a stable temperature within $\pm 0.5^{\circ}\text{C}$. The compressor should run continually when the unit is on.

Refrigeration: Please listen to hear if the refrigeration compressor is running or not. Note the absence of compressor noises on the SDRAP form. The operation of the compressor in a noisy environment can also be detected from feeling for vibrations on the lower back of the unit.

Cooling issues can also be generated by a failure of the blower fan in the cultivation chamber.

- 2) Is the Over Temperature Limit Activated indicator illuminating? Answer yes if the light is on continually or if it is pulsing.



OVER TEMPERATURE ACTIVATED

Share!

Share the SDRAP and Unit Specifications data with Technical Support. This data is crucial for offsite personnel making accurate remote diagnoses. The information is used to help ensure service techs are dispatched with the tools and parts needed to fix your unit during the first visit.

Facilities Technicians

SDRAP and Unit Specifications data are also useful to any institutional repair technicians at your facility who may be responsible for servicing of out-of-warranty units.

End Diagnostic Data Procedure

UNIT SPECIFICATIONS

The SRI21D is a 115 voltage unit. **Please refer to the chamber's data plate for individual electrical specifications.**

Technical data specified applies to units with standard equipment at an ambient temperature of 25°C and a voltage fluctuation of ±10%. The temperatures specified are determined in accordance to factory standard following DIN 12880 respecting the recommended wall clearances of 10% of the height, width, and depth of the inner chamber. All indications are average values, typical for units produced in the series. We reserve the right to alter technical specifications at all times.

WEIGHT

Shipping	Net Weight
381 lb / 173 kg	267.0 lb / 121.0 kg

DIMENSIONS

In inches

Exterior W × D × H	Interior W × D × H
36.5 x 34.5 x 79.0 in	27.0 x 23.0 x 56.5 in

In millimeters

Exterior W × D × H	Interior W × D × H
927 x 877 x 2007 mm	686 x 585 x 1435 mm

CAPACITY

Cubic Feet	Liters
20.3	575.0

UNIT SPECIFICATIONS

MAX SHELVES FOR UNIT

Shelves
4

SHELF CAPACITY BY WEIGHT

Per Shelf	Total
20.0 lb / 9.0 kg*	80.0 lb / 36.0 kg

*20lbs / 9kg with the weight evenly distributed across the shelf.

TEMPERATURE

Temp Range	Uniformity
0° to 45°C	±0.5° @ 20°C

POWER

Model	Voltage	Amperage	Frequency
SRI21D	115	9.0	50/60 Hz

Ordering Parts and Consumables

If you have the Part Number for an item, you may order the item directly from Sheldon Manufacturing by calling 1-800-322-4897 extension 3. If you are uncertain that you have the correct Part Number or if you need that specific part, please contact Sheldon Technical Support for help at 1-800-322-4897 extension 4 or (503) 640-3000. Please have the **model number** and **serial number** of the chamber ready, as Tech Support will need this information to match your unit to its correct part.

A large, light grey graphic of a stylized eye or lens is centered on the page. It consists of a large outer circle, a smaller inner circle, and a thick grey line that curves from the top left, around the top, and down the right side, forming the shape of an eye.

SHELDON
MANUFACTURING, INC

P.O. Box 627
Cornelius, OR 97113
USA

support@sheldonmfg.com
sheldonmanufacturing.com

1-800-322-4897
(503) 640-3000
FAX: 503 640-1366