

FLY INCUBATORS

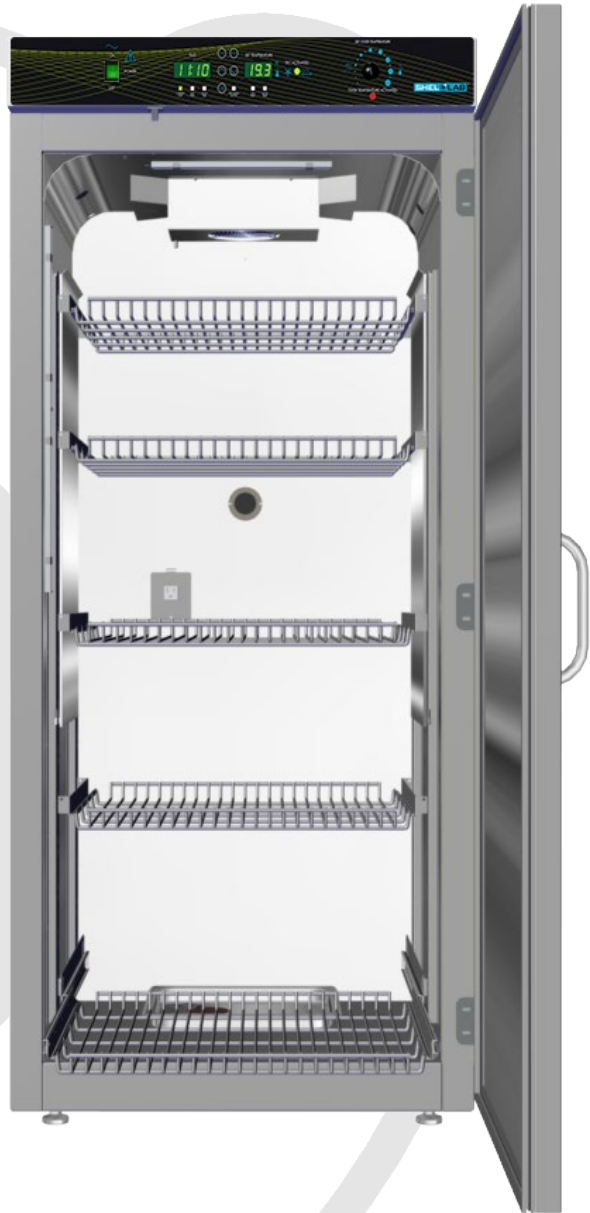

Installation - Operation Manual

SRI6PF, SRI6PF-2, SRI20PF, SRI20PF-2

For Fly Cultivation

This unit is designed for the growth, cultivation, incubation, and storage of fruit flies (*Drosophila melanogaster*). Other models are specifically manufactured for biological oxygen demand applications.

Use of this unit outside its intended range of applications voids the manufacturing defect warranty. If you have any questions, consult your incubator dealer or customer service representative to identify a model suitable for your study or process.

Pictured on Cover: SRI6PF left, SRI20PF right

Warning: This product contains chemicals, including triglycidyl isocyanurate, known to the State of California to cause cancer as well as birth defects or other reproductive harm. For more information, go to www.P65Warnings.ca.gov.



¡Advertencia! Este producto contiene sustancias químicas, incluido el triglicidil isocianurato, que el estado de California sabe que causa cáncer, así como defectos de nacimiento u otros daños reproductivos. Para obtener más información, visite www.P65Warnings.ca.gov.

Avertissement! Ce produit peut vous exposer à des produits chimiques, dont l'isocyanurate de triglycidyle, reconnu par l'État de Californie pour provoquer le cancer, des anomalies congénitales ou d'autres problèmes de reproduction. Pour plus d'informations, visitez le site www.P65Warnings.ca.gov.

SHEL LAB Refrigerated Incubator Peltier FLY

100 – 120 Voltage Models: SRI6PF and SRI20PF

220 – 240 Voltage Models: SRI6PF-2 and SRI20PF-2

Part Number (Manual): 4861674-1

Revision: August 13, 2024

TABLE OF CONTENTS

MODEL CERTIFICATIONS	7
<i>Electromechanical and Heating Safety</i>	<i>Error! Bookmark not defined.</i>
<i>CE Compliant</i>	<i>Error! Bookmark not defined.</i>
<i>UKCA Compliant</i>	<i>Error! Bookmark not defined.</i>
<i>ISO Certified Manufacturer</i>	<i>Error! Bookmark not defined.</i>
INTRODUCTION	9
<i>Read this Manual</i>	9
<i>Safety Considerations and Requirements</i>	9
<i>Contacting Assistance</i>	11
<i>Manufacturing Warranty</i>	11
<i>Engineering Improvements</i>	11
<i>Temperature Reference Sensor Device</i>	12
RECEIVING YOUR UNIT	14
<i>Inspect the Shipment</i>	14
<i>Orientation Photos</i>	16
<i>Recording Data Plate Information</i>	19
INSTALLATION	21
<i>Installation Procedure Checklist</i>	21
<i>Required Ambient Conditions</i>	22
<i>Required Clearances</i>	23
<i>100 – 120 Volt Power Source Requirements</i>	24
<i>220 – 240 Volt Power Source Requirements</i>	26
<i>Lifting and Handling</i>	27
<i>Removing from the Pallet</i>	27
<i>Leveling</i>	27
<i>Install the Incubator</i>	29
<i>Deionized and Distilled Water</i>	29
<i>Installation Cleaning and Disinfection</i>	29
<i>Install the SRI20PF Side Air Ducts</i>	30
<i>Shelving Installation</i>	32
<i>Access Port Stopper</i>	35
GRAPHIC SYMBOLS	37
CONTROL PANEL OVERVIEW	39
OPERATION	41
<i>Theory of Operation</i>	41
<i>Put the Incubator into Operation</i>	45
<i>Set Clock and Cycle Mode Start Times</i>	47
<i>Set the Night Mode Temperature</i>	49
<i>Set the Day Mode Temperature</i>	51
<i>Set the Over Temperature Limit</i>	53
<i>Loading Samples</i>	56
<i>Day – Night Auto-cycle</i>	56
<i>Chamber Power Outlet</i>	57
<i>Humidifying the Incubator</i>	57
<i>Condensation and the Dew Point</i>	58
<i>Door Alarm Setting</i>	59
USER MAINTENANCE	62
<i>Cleaning and Disinfecting</i>	62
<i>Door Components</i>	63

Electrical Components 63
Calibrate the Temperature display..... 64
UNIT SPECIFICATIONS**73**
Weight..... 73
Dimensions..... 73
Capacity..... 73
Shelf Capacity by Weight 74
Power..... 74
Temperature..... 75
PARTS AND CONSUMABLES**77**

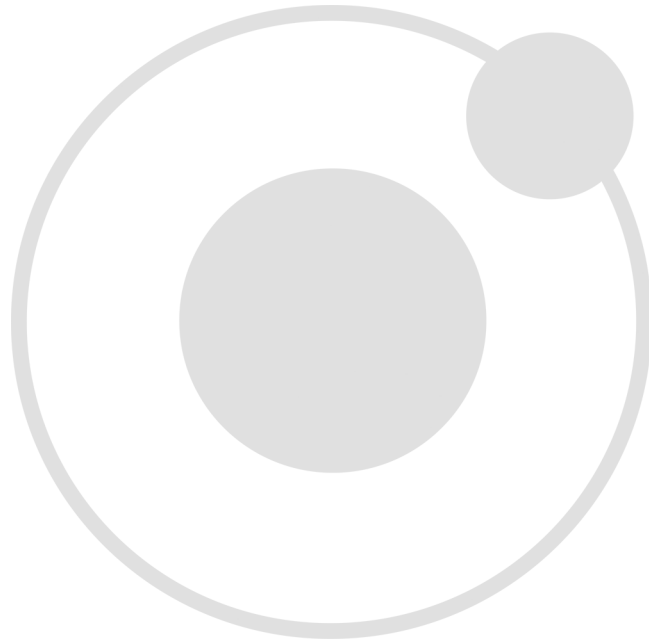

MODEL CERTIFICATIONS

ISO CERTIFIED MANUFACTURER



SHEL LAB is a brand of Sheldon Manufacturing, INC, an ISO 9001 certified manufacturer.

The model units represented in this manual were tested and found to be in conformity with the following standards:

IEC 61010-1:2010/AMD1:2016

IEC 61010-2-010:2019



INTRODUCTION

Thank you for purchasing a SHEL LAB incubator. We know you have many choices in today's competitive marketplace when it comes to constant temperature equipment. We appreciate you choosing ours. We stand behind our products and will be here if you need us.

READ THIS MANUAL

Failure to follow the guidelines and instructions in this user manual may create a protection impairment by disabling or interfering with the unit safety features. This can result in injury or death.

Before using the unit, read the manual in its entirety to understand how to install, operate, and maintain the unit in a safe manner. Ensure all operators are given appropriate training before the unit begins service.

Keep this manual available for use by all operators.

SAFETY CONSIDERATIONS AND REQUIREMENTS

Follow basic safety precautions, including all national laws, regulations, and local ordinances in your area regarding the use of this unit. If you have any questions about local requirements, please contact the appropriate agencies.

SOPs: Because of the range of potential applications this unit can be used for, the operator or their supervisors must draw up a site-specific standard operating procedure (SOP) covering each application and associated safety guidelines. This SOP must be written and available to all operators in a language they understand.

Intended Applications and Locations: The incubators are intended for constant temperature, non-humidified microbiological incubation applications in professional, industrial, and educational environments. The units are not intended for use at hazardous or household locations.

Power: Your unit and its recommended accessories are designed and tested to meet strict safety requirements.

- The unit is designed to connect to a power source using the specific power cord type shipped with the unit.
- Always plug the unit power cord into a protective earth grounded electrical outlet conforming to national and local electrical codes. If the unit is not grounded properly, parts such as knobs and controls can conduct electricity and cause serious injury.
- Do not bend the power cord excessively, step on it, or place heavy objects on it.
- A damaged cord can be a shock or fire hazard. Never use a power cord if it is damaged or altered in any way.

- Use only approved accessories. Do not modify system components. Any alterations or modifications to your unit not explicitly authorized by the manufacturer can be dangerous and will void your warranty.

CONTACTING ASSISTANCE

Phone hours for Sheldon Customer Support are 6 am – 4:30 pm Pacific Coast Time (west coast of the United States, UTC -8), Monday – Friday. Please have the following information ready when calling or emailing Customer Support: the **model number**, **serial number**, and **part number** (see page 19).

support@sheldonmfg.com
1-800-322-4897 extension 4
(503) 640-3000 extension 4

Sheldon Manufacturing, INC.
P.O. Box 627
Cornelius, OR 97113
USA

MANUFACTURING WARRANTY

For information on your warranty and online warranty registration please visit:

sheldonmanufacturing.com/warranty

ENGINEERING IMPROVEMENTS

Sheldon Manufacturing continually improves all of its products. As a result, engineering changes and improvements are made from time to time. Therefore, some changes, modifications, and improvements may not be covered in this manual. If your unit's operating characteristics or appearance differs from those described in this manual, please contact your SHEL LAB dealer or customer service representative for assistance.

TEMPERATURE REFERENCE SENSOR DEVICE

Must be purchased separately

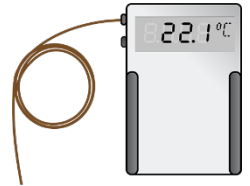

Temperature Reference

Temperature Calibrations

If you are not using a third-party service, a reference sensor device is required for calibrating your unit's temperature display.

- See the **Calibrating the Temperature Display** procedure on page 64 for more information.

Device Accuracy

Reference devices must meet the following standards:

- Accurate to at least 0.1°C

The device should be regularly calibrated, preferably by a third party.

Temperature Probe

Use a digital device with a wire thermocouple probe that can be introduced into the unit chamber through the access port or door space. Select a thermocouple suitable for the application temperature you will be calibrating at.

Why a Probe?

Reference readings taken from outside the chamber using wire temperature probes avoid chamber door openings. Openings disrupt the chamber temperature. Each disruption requires **a minimum 1-hour wait** to allow the chamber to re-stabilize before continuing.

No Alcohol or Mercury Thermometers

Alcohol thermometers do not have sufficient accuracy to conduct accurate temperature calibrations. **Never place a mercury thermometer in the unit chamber.** Always use thermocouple probes.

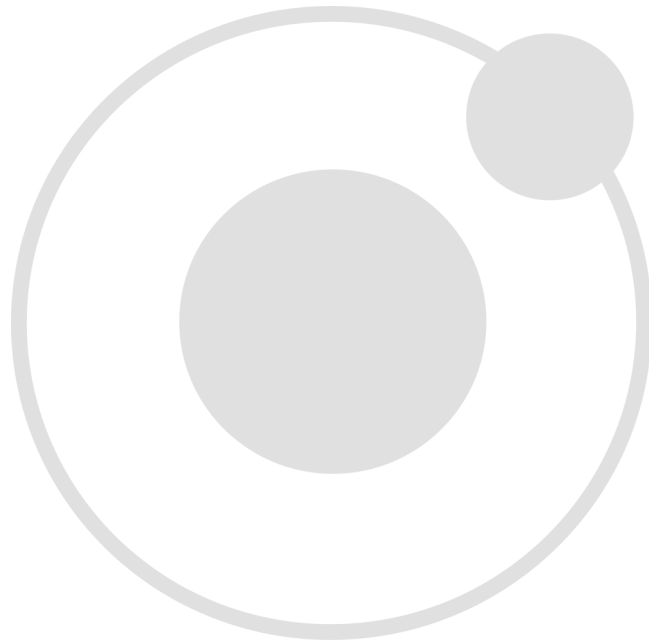

RECEIVING YOUR UNIT

INSPECT THE SHIPMENT

- When a unit leaves the factory, safe delivery becomes the responsibility of the carrier.
- **Damage sustained during transit is not covered by the manufacturing defect warranty.**
- Save the shipping carton until you are certain that the unit and its accessories function properly.

When you receive your unit, inspect it for concealed loss or damage to its interior and exterior. If you find any damage to the unit, **follow the carrier's procedure for claiming damage or loss.**

1. Carefully inspect the shipping carton for damage.
2. Report any damage to the carrier service that delivered the unit.
3. If the carton is not damaged, open the carton and remove the contents.
4. The unit should come with an Installation and Operation Manual.
5. Verify that the correct number of accessory items have been included.

Model	Shelves	Static Shelf Brackets	Sliding Shelf Brackets
SRI6PF	2	4	0
SRI20PF	5	8	2

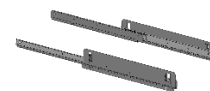
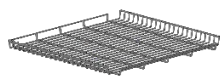

Model	Leveling Feet	Power Cord	Humidification Pan	Side Air Duct Panels
SRI6PF	4	1	1	0
SRI20PF	4	1	1	2



6. A rubber stopper should come installed in the access port inside the incubation chamber. Verify the presence of the stopper.

7. Carefully check all packaging for accessories before discarding.

RECEIVING

ORIENTATION PHOTOS

SRI20PFs

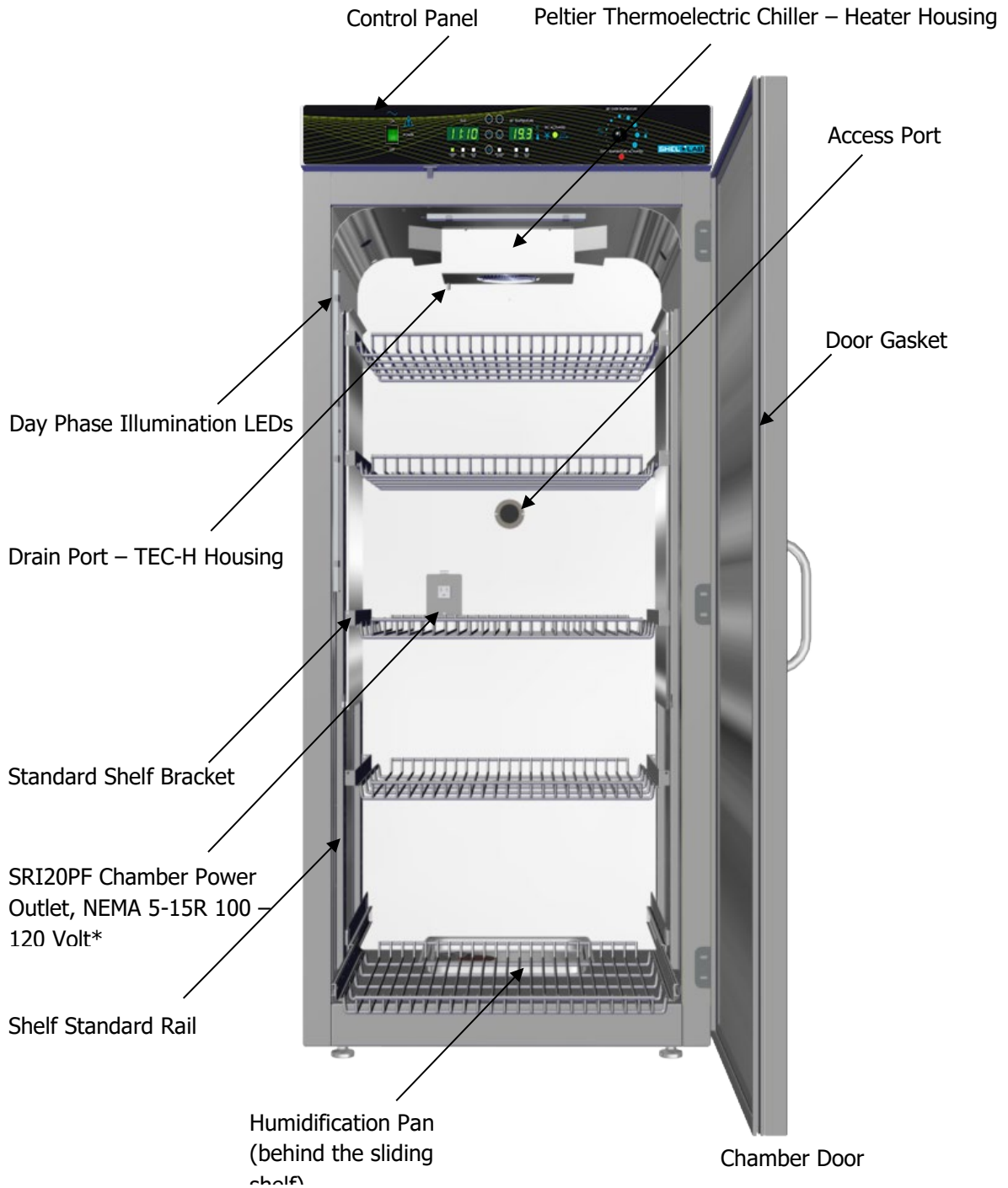

*SRI20PF-2 Chamber Power Outlet, CEE7/3 220 – 240 Volt

SRI6PF

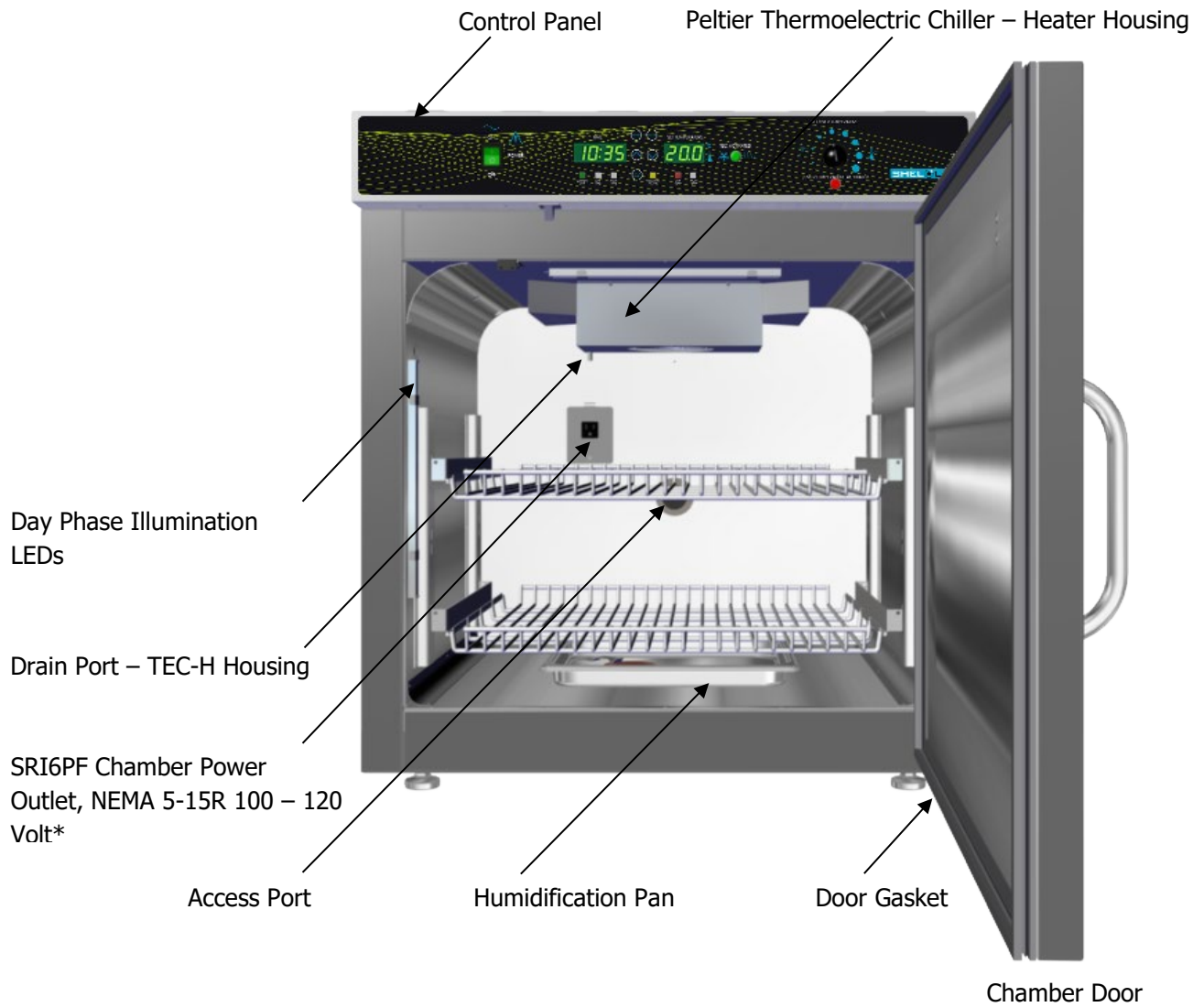

*SRI6PF-2 Chamber Power Outlet, CEE7/3 220 – 240 Volt

RECEIVING

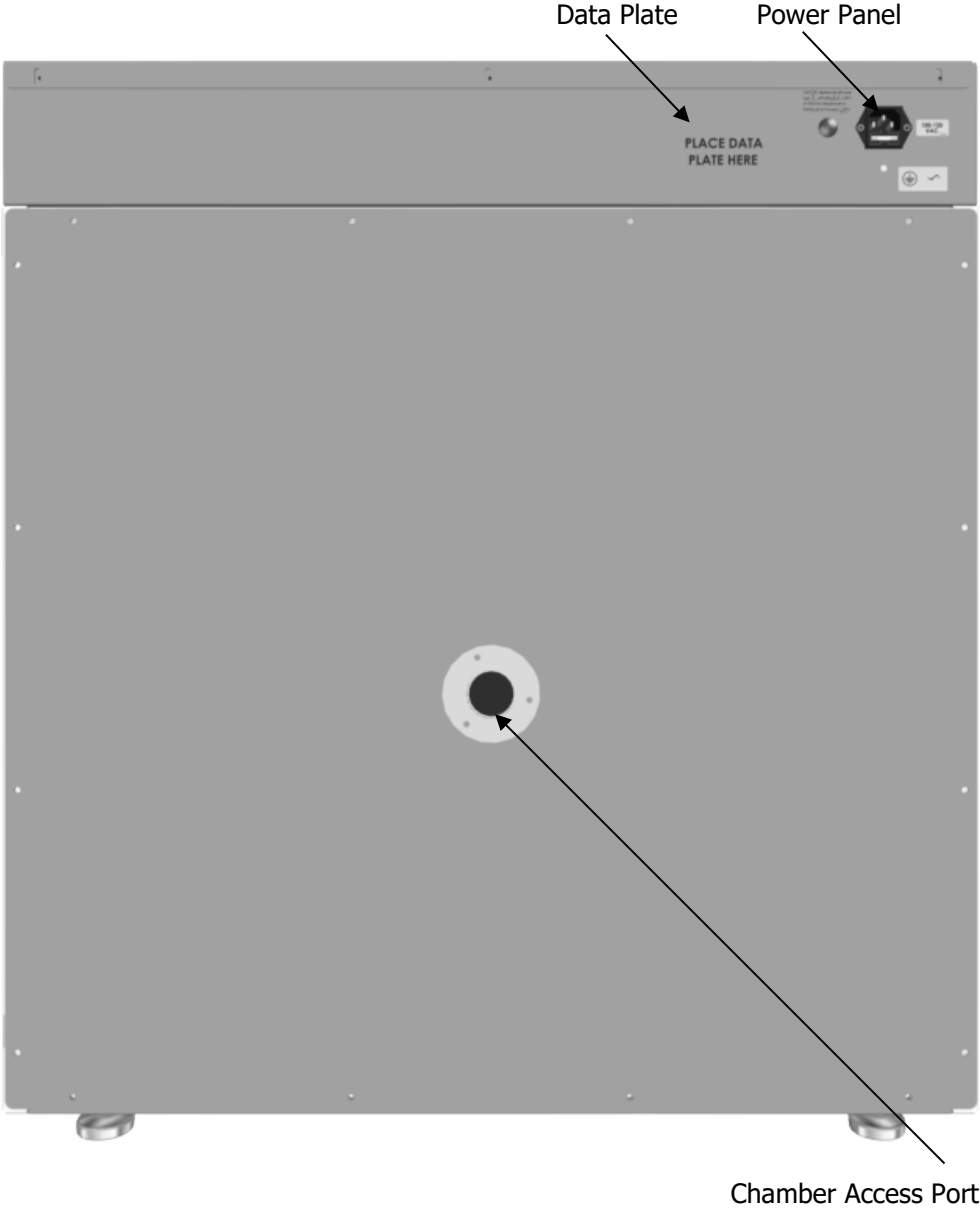

Second Fuse Holder (220V Incubators only)

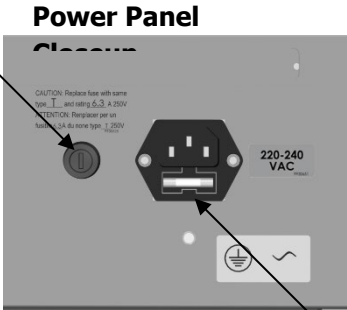

Power Cord Inlet with Fuse Holder

RECORDING DATA PLATE INFORMATION

Record the unit **model number**, **serial number**, and **part number** below for future reference. Customer Support needs this information to provide accurate help during support calls and emails.

- The data plate is located on the left exterior wall of the incubator, toward the back and just above the power cord inlet.

MODEL NO:	
SERIAL NO:	
PART NO:	

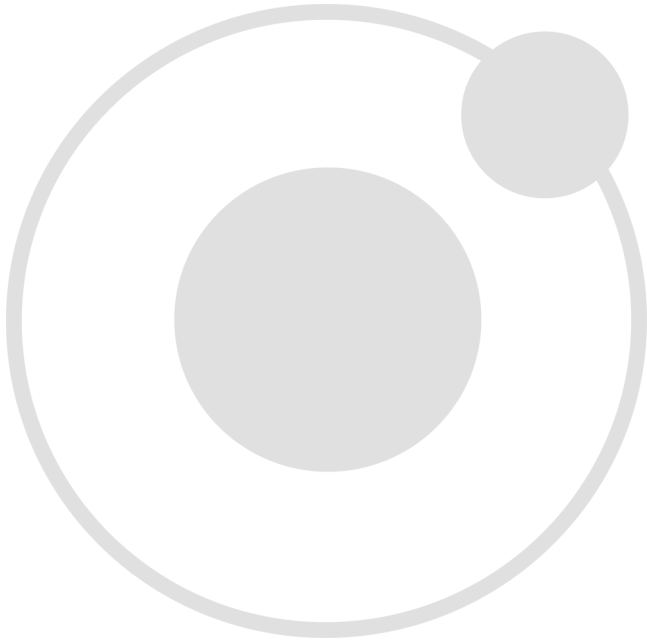

INSTALLATION PROCEDURE CHECKLIST

Carry out the procedures and steps listed below to install the incubator in a new workspace location and prepare it for use. All procedures are found in the Installation section of this manual.

Pre-Installation

- ✓ Check that the required ambient condition for the unit are met, page 22
- ✓ Check that the spacing clearance requirements are met, page 23
 - Unit dimensions may be found on page 7070
- ✓ Check that a suitable electrical outlet and power supply is present, page 24

Installing the Incubator in a suitable workspace location

- ✓ Review the lifting and handling instructions, page 27
- ✓ Make sure the incubator is level, page 27
- ✓ Install the incubator in its workspace location, page 29.

Set up the Incubator for use

- ✓ Clean and disinfect the unit and shelving (recommended), page 29
- ✓ SRI20PF only: Install the side air ducts inside the incubation chamber, page 30
- ✓ Install the shelving, page 32
- ✓ Verify the stopper has been installed in the access port, page 35

REQUIRED AMBIENT CONDITIONS

Ambient Temperature Ranges: These units are built for use indoors under climate-controlled conditions of **15.0°C to 30.0°C** (59.0°F to 86.0°F).

SRI6PF Ambient Impact on Cooling

- In workspace temperatures of **15.0°C to 27.0°C** (59.0°F to 80.6°F) the SRI6PF incubators can achieve an operational chamber temperature range of 15.0°C to 40.0°C.
- Sustained workspace temperatures of **27.1°C to 30.0°C** (80.7°F to 86°F) will gradually raise the lowest achievable incubation chamber temperature. See page 75.

SRI20PF Ambient Impact on Cooling

- In workspace temperatures of **15°C to 25.0°C** (59°F to 77.0°F) the SRI20PF incubators can achieve an operational chamber temperature range of 15.0°C to 40.0°C.
- Sustained workspace temperatures of **25.1°C to 30°C** (77.1°F to 86.0°F) will gradually raise the lowest achievable incubation chamber temperature. See page 75.

The following ambient conditions will affect the unit temperature performance.

- **Ambient Temperature Variation:** The workspace temperature should not change by 2°C (3.6°F) or more during operation.
- **Maximum Humidity:** No greater than 80% Relative Humidity (at 25°C / 77°F).

Air Quality: The units are rated to operate in a Pollution Degree 2 environment.

Maximum Altitude: 2000 meters (6562 feet).

Additional Environmental Factors: When selecting a location to install the unit, consider all environmental conditions that can adversely impact its temperature performance. These include:

- Proximity to ovens, autoclaves, or any other device producing significant radiant heat.
- Heating and cooling vents or other sources of fast-moving air currents.
- High-traffic areas.
- Direct sunlight.

INSTALLATION

REQUIRED CLEARANCES

These clearances are required to provide airflows for ventilation and cooling.

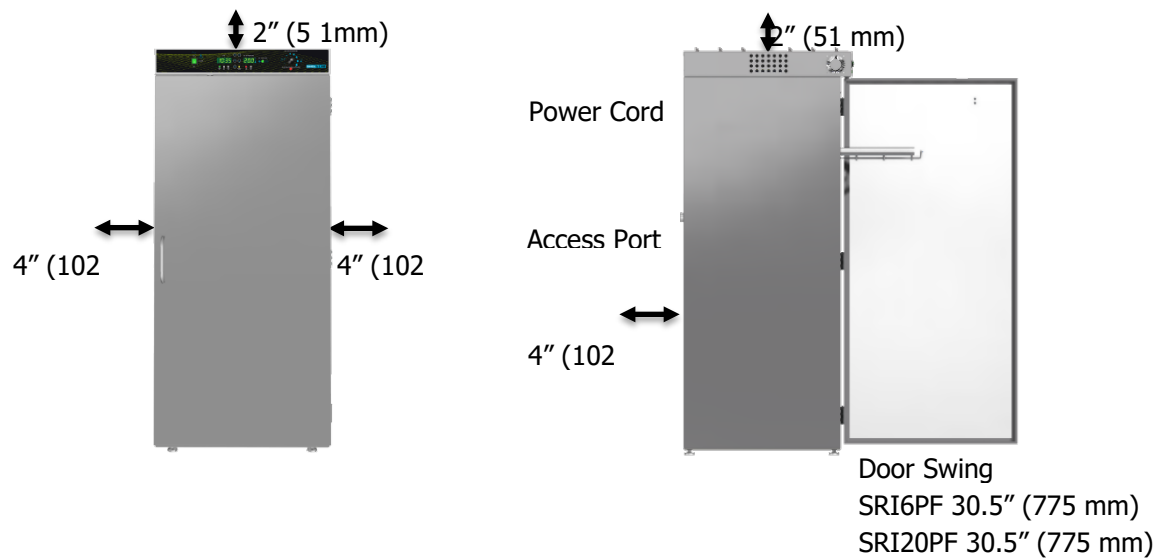

4 inches (102 mm) of clearance is required on the sides and back.

2 inches (51 mm) of headspace clearance between the top of the unit and any overhead partitions.

INSTALLATION

Note: See the next page for the -2, 220-volt incubators.

100 – 120 VOLT POWER SOURCE REQUIREMENTS

Applies to: SRI6PF and SRI20PF

When selecting a location for the unit, verify each of the following requirements is satisfied.

Power Source: The power source must match the voltage and amperage requirements listed on the unit data plate. These units are intended for **100 – 120V 50/60 Hz** applications at the following amperage

Standard
NEMA 5-15R
wall socket

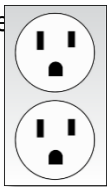

Model	Amperage
SRI6PF	4.0 Amps
SRI20PF	5.5 Amps

- The wall power source must be protective earth grounded.
- **The unit may be damaged if the supplied voltage varies by more than 10% from the data plate rating.**
 - The unit is safety-rated to withstand transient overvoltage levels up to Overvoltage Category II.
- Use a separate circuit to prevent loss of the unit due to overloading or circuit failure.
- **The recommended wall circuit breaker for this unit is 15 amps.**
- The wall power source must conform to all national and local electrical codes.

Power Cord: The unit must be positioned so that all end-users can quickly unplug the cord in the event of an emergency.



- Each unit comes provided with a **125 volt, 15 Amp, 8.2ft (2.5m) NEMA 5-15P** power cord.
- Always use this cord or an identical replacement.

Fuses: These units each ship with a fuse installed in the power cord inlet.



- The fuse must be installed and intact for the unit to operate.
- Always find and fix the cause of a blown fuse prior to putting the unit back into operation.

- Fuse type: 250V, T6.3A, 5X20 mm

INSTALLATION

220 – 240 VOLT POWER SOURCE REQUIREMENTS

Applies to: SRI6PF-2 and SRI20PF-2

When selecting a location for the unit, verify each of the following requirements is satisfied.

Power Source: The power source for the unit must match the voltage and match or exceed the ampere requirements listed on the unit data plate. These units are intended for **220 – 240V 50/60 Hz** AC power sources at the following amperages:

CEE7 sockets
compatible with
CEE7/7 plugs

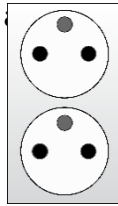

Model	Amperage
SRI6PF-2	3.0 Amps
SRI20PF-2	3.5 Amps

- The wall power source must be protective earth grounded.
- **The unit may be damaged if the supplied voltage varies by more than 10% from the data plate rating.**
 - The unit is safety-rated to withstand transient overvoltage levels up to Overvoltage Category II.
- Use a separate circuit to prevent loss of the unit due to overloading or circuit failure.
- **The recommended wall circuit breaker for this unit is 16 amps.**
- The wall power source must conform to all national and local electrical codes.

Power Cord: The unit must be positioned so that all end-users can quickly unplug the cord in the event of an emergency.



- Each unit is provided with a **230V, 10 Amp, EUR16P, CEE 7/7, 2.5 meters (8.2ft)**. Always use this cord or an identical replacement.

Fuses: These units each ship with a fuse installed in the power cord inlet and a second fuse installed in an adjacent fuse holder.



- Both fuses must be installed and intact for the unit to operate.
- Always find and fix the cause of a blown fuse prior to putting the unit back into operation.
- Fuse type: T6.3A, 250V, 5X20 mm

INSTALLATION

LIFTING AND HANDLING

The unit is heavy. Use appropriate lifting devices that are sufficiently rated for these loads. Follow these guidelines when lifting the unit.

- Lift the unit only from its bottom surface.
- Doors, handles, and knobs are not adequate for lifting or stabilization.
- Restrain the unit completely while lifting or transporting so it cannot tip.
- Remove all moving parts, such as shelves and trays, and lock doors in the closed position during transfers to prevent shifting and damage.

REMOVING FROM THE PALLET

The unit comes secured to a shipping pallet with ½" hex bolts inserted through the 4 leveling feet holes on the bottom of the incubator. Use a socket wrench to remove the bolts and release the unit from the pallet.

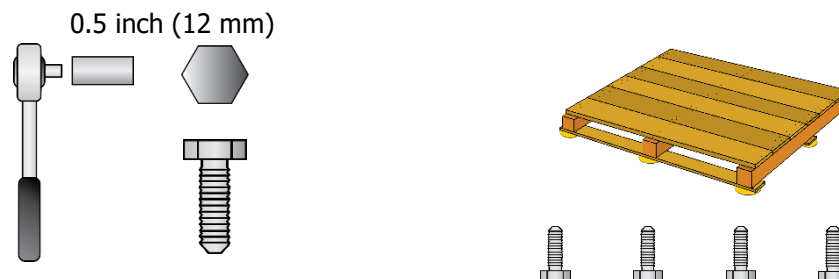

LEVELING

Install the 4 leveling feet in the 4 corner holes on the bottom of the unit. The unit must be level and stable for safe operation and to ensure condensate drains properly from the heater – chiller housing in the incubation chamber.

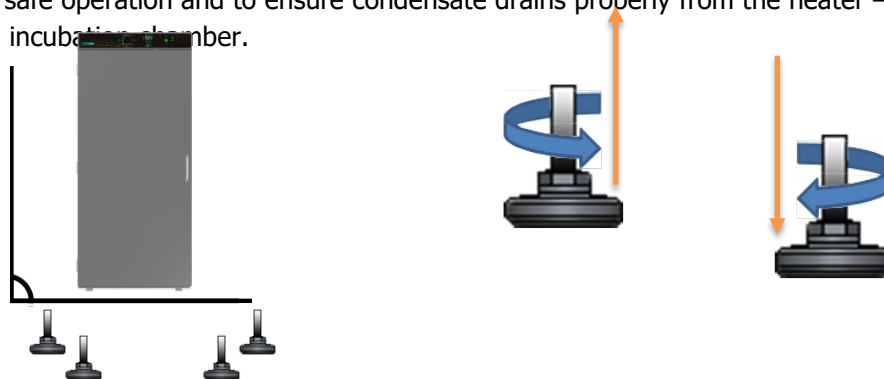

Note: To prevent damage when moving the unit, turn all 4 leveling feet so that the leg of each

foot sits inside the unit.

INSTALL THE INCUBATOR

Install the unit in a workspace location that meets the criteria discussed in the previous entries of the Installation chapter.

DEIONIZED AND DISTILLED WATER

Do not use deionized water to clean the unit, even if DI water is readily available in your laboratory.

- The use of deionized water may corrode metal surfaces and **voids the manufacturing warranty**.
- The manufacturer recommends the use of distilled water in the resistance range of 50K Ohm/cm to 1M Ohm/cm, or a conductivity range of 20.0 uS/cm to 1.0 uS/cm, for cleaning applications.

INSTALLATION CLEANING AND DISINFECTION

The manufacturer recommends cleaning the shelving and chamber before installing the shelving in the chamber.

- The unit was cleaned at the factory but may have been exposed to contaminants during shipping.
- Remove all wrappings and coverings from shelving prior to cleaning and installation. **Do not clean the shelving with deionized water.**
- Please see the [Cleaning and Disinfection](#) procedure on page 62 in the User Maintenance chapter for information on how to clean and disinfect without damaging the unit.

INSTALLATION

INSTALL THE SRI20PF SIDE AIR DUCTS

Two air duct panels are packed with the accessories of the SRI20PF incubators.

Installation

Insert the panel hooks, facing down, into the large notches in the shelf standard mounting rails.



SRI6PF incubators do not use Side Air Ducts.

Note: The air duct panels play an important role in maintaining even air distribution inside the SRI20PF incubation chamber. Failure to install both air duct panels may adversely impact

temperature uniformity.

INSTALLATION

SHELVING INSTALLATION

Static Shelves Installation

Remove all protective wrappings from shelves and shelving components prior to installation.

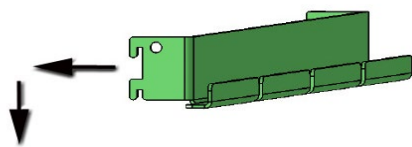

Standard Shelf Bracket Installation

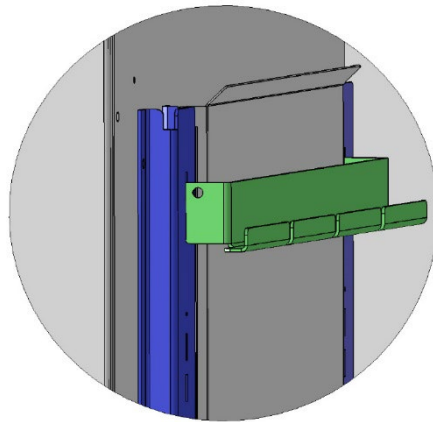

Standard Bracket Installed

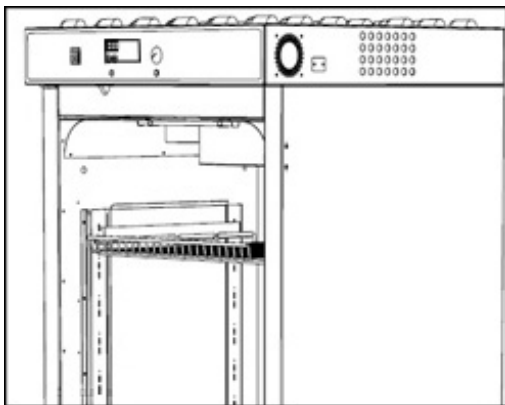

Shelf hung from mounting bracket

1. Insert the twin tabs on the bracket into slots in the shelf standard mounting rails located on the sides of the incubation chamber.
2. Slide the bracket down so it sits securely attached to the shelf standard rails.
3. Repeat the process on the opposite side of the chamber with a second bracket.
4. Hang one shelf from the two installed brackets.

INSTALLATION

Shelving Installation Continued

Sliding Shelf Installation SRI20PF

Note: SRI6PF does not come with sliding shelf brackets. Sliding brackets for SRI6PF must be purchased separately.

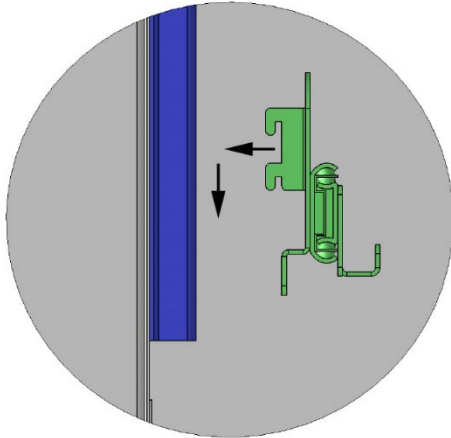

1. Insert the sliding shelf mounting bracket tabs

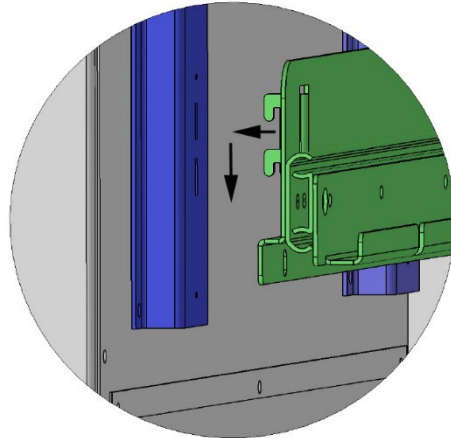

2. Slide the bracket down

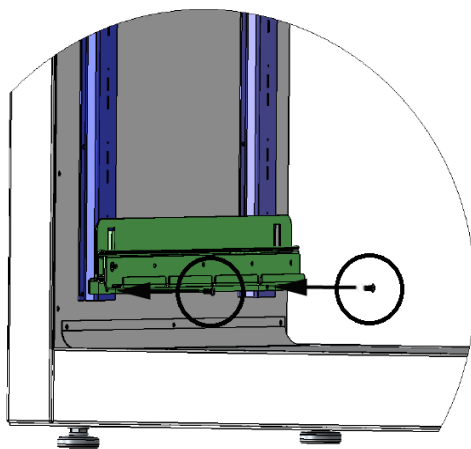

3.1. Insert the bracket screws

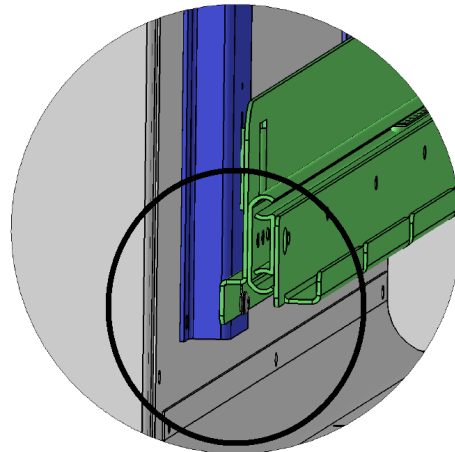

3.2 Tighten the screws.

1. Insert the sliding bracket's twin tabs into the shelf standard mounting slots located on the sides of the incubator chamber.
2. Slide the bracket down so it sits securely attached to the shelf standard mounting rails.
3. Insert and tighten two screws. The holes are located on the front and back of the bracket.
4. Repeat the process on the opposite side of the chamber for a second sliding bracket.

5. Hang one shelf from the two installed sliding brackets.

ACCESS PORT STOPPER

Each incubator ships with a rubber stopper installed in the access port located in the back of the incubation chamber.





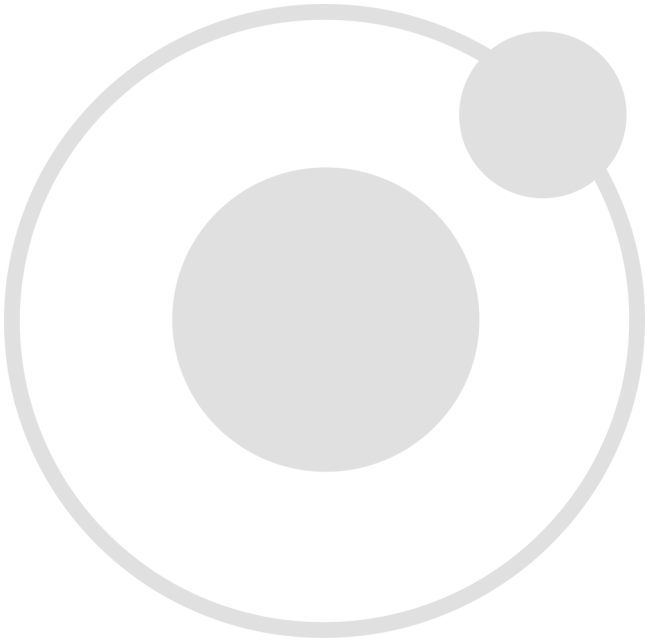



- The stopper should **always be installed inside the chamber** to obtain the best temperature uniformity and prevent condensation from forming inside the port. Do not install on the outside of the port on the back of the unit.
- Wires for thermocouples and other sensor probes may be introduced into the chamber through the access port. The stopper may be placed over the wires.



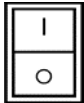

GRAPHIC SYMBOLS

The unit is provided with multiple graphic symbols on its exterior. The symbols identify hazards and the functions of the adjustable components, as well as important notes in the user manual.

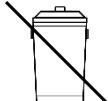
Symbol	Definition
	Consult the user manual. Consulter le manuel d'utilisation
	Temperature display Indique l'affichage de la température
	Over Temperature Limit system Thermostat température limite contrôle haute
	AC Power Repère le courant alternatif
	I/ON O/OFF I indique que l'interrupteur est en position marche. O indique que le commutateur est en position d'arrêt.
	Protective earth ground Terre électrique
	Adjusts UP and DOWN Ajuster la température de l'incubateur vers le haut et vers le bas
	Manually adjustable Indique un réglage manuel
	Recycle the unit. Do not dispose of it in a landfill. Recycle l'unité. Ne jetez pas dans une décharge.

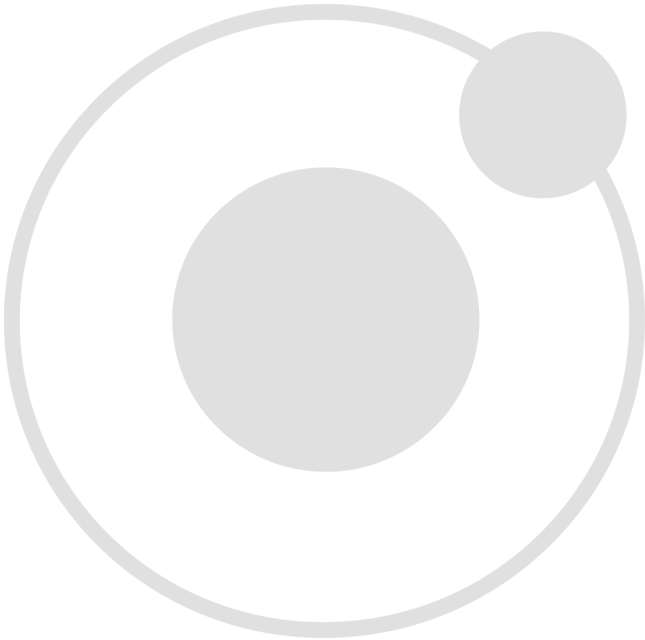

CONTROL PANEL OVERVIEW

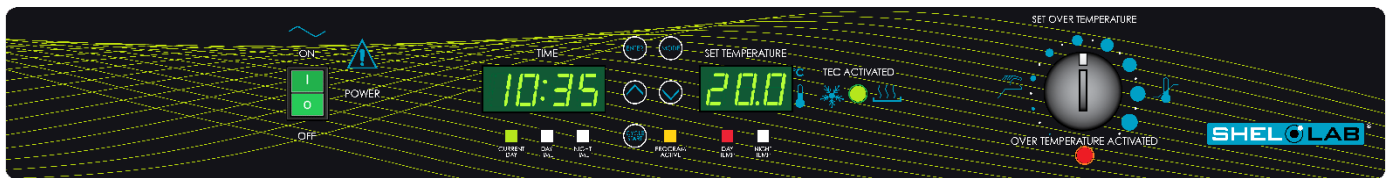

Power Switch

Power is supplied and the switch illuminates when in the (I) ON position.



Time Display

This display operates as a 24-hour clock (00:00 – 23:59), showing the current time. The display is also used to set the **Daytime start time** and the **Nighttime start time** for the day – night illumination and heating autcycle.

Three LED indicators immediately below the display indicate which time is showing. The green **Current Day** lamp indicates the display is showing clock time. When setting start times for the Day – Night Autcycle, the Day Time and Night Time lamps indicate which start time is being displayed.

Temperature Display

Shows the current incubation chamber air temperature accurate to 0.1°C. It can also be placed in setpoint or calibration adjustment modes. When navigating to these modes, the display will show "SP" for Setpoint or "C O" for Calibration Offset.



Just below the Temperature Display are two LED lights, **Day Temp** and **Night Temp**. These indicate which mode the incubator is running in as well as which mode's temperature setpoint is being displayed when adjusting programmed temperatures.

Control Arrow Buttons

Temperature functions: By default, the arrow buttons adjust the temperature setpoints of the Day and Night Modes. Additionally, these controls can be used to turn the Door Open Alarm off or on when adjusting the temperature setpoint (DO = door alarm off, DI = door alarm on).



These buttons can also be used to place the temperature display in its calibration mode, then to make calibration adjustments to match the display to a reference device temperature reading.

Time functions: When the time display is in the Time Set Up menu, the arrow buttons adjust the Current Time, then the autcycle Daytime and then Nighttime start times.



Enter Button

Saves adjustments to the Current Time and the autocycle start times while in the Time Set Up menu. The Enter button can also be used to scroll forward through the menu without changing individual time settings.



Mode Button

Pushing the Mode button enters the Time Setup menu. **Pressing and holding** the Mode button for 5 seconds manually switches the incubator between the Daytime and Nighttime modes when the Day – Night Autocycle is not running.



Cycle Start Button

This button launches the Day – Night Autocycle. To do so, press and hold for 2 seconds. The green PROGRAM ACTIVE indicator illuminates when the Autocycle is running. Pressing and holding while the indicator is lit terminates an active cycle.



Heating and Cooling Indicator Light

The green TEC ACTIVATED light illuminates whenever the Peltier TEC-H device is actively cooling or heating the chamber. This light will illuminate frequently during normal operations.



Set Over Temperature

This graduated dial sets the mechanical heating cutoff point for the Over Temperature Limit system. The system prevents unchecked heating of the chamber in the event of a hardware failure or external heat spike. For more details, please see the [Over Temperature Limit System](#) description in the Theory of Operations (page 43).



The red light illuminates when the Over Temperature system cuts power to the Peltier heating circuits.

THEORY OF OPERATION

SRIPF fly incubators provide a variable temperature and illumination environment suitable for the cultivation and storage of fruit flies (*Drosophila melanogaster*).

Heating and Cooling

The incubator employs a solid-state thermoelectric cooling-and-heating (TEC-H) device, which operates using the Peltier effect to supply heating or cooling as needed.

The Peltier effect: An electrical current between two touching but dissimilar conductor plates produces a heat flow from one plate to the other. The flow direction can be flipped by reversing the current direction. The sandwiched TEC-H conductors effectively operate as a reversible high-efficiency heat pump. A fan attached to the TEC-H blows air-cooled or heated by the chamber-side Peltier plate into the chamber interior to achieve the current setpoint target temperature.

When powered, the incubator automatically heats or chills to and then maintains the operator-selected temperature setpoint. The unit controller senses the chamber air temperature via a solid-state probe located in the unit interior. When the unit controller detects a temperature deviation from the target setpoint, it pulses power to the Peltier thermoelectric cooling and heating (TEC-H) device.

The unit controller uses Proportional – Integral – Derivative (PID) algorithms to avoid significantly overshooting the setpoint. This means the rate of heating or cooling slows as the temperature approaches the target temperature.

Additionally, the PID loops optimize heating and cooling rates for the temperature environment around the incubator. If the incubator is operating in a cool room, it will increase the length of heating pulses to compensate. Likewise, when operating in a warm room the unit uses shorter pulses to heat. If the ambient temperature conditions are significantly changed, there may be minor over or undershoots as the unit adapts.

Modes of Operation

The incubator runs in one of two modes, Daytime or Nighttime. In its Daytime mode, the incubator provides continual illumination in the incubation chamber using a white light LED array mounted on the left chamber wall. In Nighttime Mode, the chamber is left dark, though a small LED bar at the top of the chamber illuminates whenever the chamber door is opened.

The Day and Night Modes have independent, programmable temperature setpoints. Both are set to 20°C at the factory but can be adjusted to different temperatures to provide thermal variation between the modes.

Manual and Autocycle

Users can manually switch between Day and the Nighttime Modes by pressing and holding the MODE button. SRIPF incubators come from the factory set to Daytime Mode.

The incubator is also provided with a Day – Night Autocycle. When launched, the cycle automatically switches between the two modes twice per day until manually terminated. As set at the factory, the cycle switch points are 12 hours apart at 08:00 (8 am) and 20:00 (8 pm). These mode “start times” can be adjusted using the incubator controls.

When running in Day Mode, the unit temperature controller automatically compensates for the small amount of heat generated by the active LED light array in the incubation chamber.

Door Alarm

The incubator is equipped with a magnetic induction door alarm, which activates when the door is open for 60 seconds. When the alarm is active, an audio alert will sound, and the temperature display will flash. Closing the door will temporarily turn off the alarm. The alarm may be turned off indefinitely using the [Door Alarm Setting](#) procedure on page 59

The Over Temperature Limit System

The mechanical OTL heating cutoff system monitors the chamber temperature using an independent hydrostatic temperature probe located in the chamber air stream. If the chamber temperature is higher than the OTL setting, the system prevents power from flowing to the Peltier TEC-H device in the direction that adds heat to the chamber. In other words, the Peltier device will not heat while the OTL system is active, but it should continue to cool the chamber.

The OTL should be set when the incubator chamber is stabilized at **your warmest application temperature**. This is typically when the unit has been functioning in the Day Mode for several hours. Setting the over temperature limit while the unit is operating in the Night Mode risks tripping the Over Temperature system when the unit transitions to a warmer day temperature.

The OTL heating cutoff limit is set **by the end-user**, normally at approximately 1°C above the application temperature. It is intended to help safeguard samples and prevent runaway heating in the event of a hardware failure or a heat spike generated inside or outside of the incubator chamber.

The OTL cutoff cannot prevent a rise in heat caused by a complete failure of the Peltier TEC-H itself. With the loss of the chilling function, the chamber temperature will rise to the ambient room temperature, plus 1 or 2°C.

OPERATION

PUT THE INCUBATOR INTO OPERATION

Carry out the following steps and procedures to put the unit into operation after installing it in a new workspace environment

1. Plug in the power cord.



Attach the power cord that came with the unit to the power inlet receptacle on the back of the incubator.

Plug the power cord into the workspace electrical outlet.

2. Turn on the incubator.

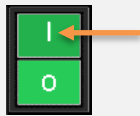

Place the incubator **Power Switch** in the ON (I) position.

- The switch and displays will illuminate.

3. Set the clock and cycle mode start times.



Perform the [Set the Clock and Cycle Mode Start Times](#) procedure on page 47.

4. Set the Night Mode temperature.

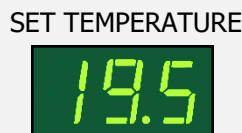

Perform the [Set the Night Mode Temperature Setpoint](#) procedure on page 49.

5. Set the Day Mode temperature.



Perform the [Set the Day Mode Temperature Setpoint](#) procedure on page 51.

6. Allow the incubator to heat soak for a minimum of 8 hours.



Run the unit for at least 8 hours (for example, overnight) with chamber door closed prior to:

- Setting the Over Temperature Limit (next step).
- Loading samples.

7. Set the Over Temperature Limit.



Perform the [Set the Over Temperature Limit](#) procedure See page 53.

- The incubator must be heated **and stable** at your application temperature prior to performing this procedure.

End of procedure

OPERATION

SET CLOCK AND CYCLE MODE START TIMES

This procedure performs the following functions:

- Sets the incubator clock time to local time.
- Optional: Adjusts the Autocycle start times for the Day and Night modes.



The incubator comes from the factory set to US Pacific Time. The Autocycle Daytime start comes from the factory set to 08:00 (8 am), and the default Nighttime start is 20:00 (8 pm).

1. Put the Time Display in Adjustment Mode.



Push the Mode button.

- The Current Day indicator will stay lit.
- The Temperature display will turn off.
- The Time display will show a blinking, adjustable clock setting.

2. Adjust the Current clock time to match your local time.

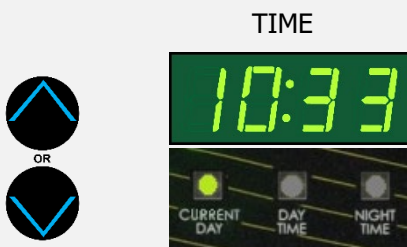

Note: Skip to the next step if you do not wish to adjust the current clock time.

Use the arrow buttons to adjust the clock setting.

3. Save the Current time and advance to the Daytime start time.

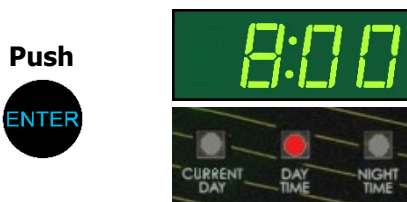

Push the Enter button.

- This saves the flashing time value shown on the display as the new Current time.
- The display will automatically advance to the Daytime mode start time.

Note: The default Day start time is 8:00 am.

4. Set the Autocycle Daytime Start Time.

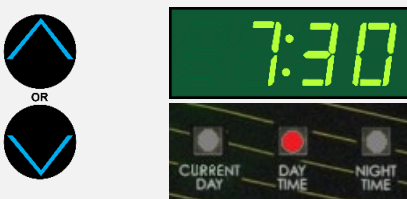

Note: Skipping this step leaves the Day Mode cycle start time set to 8 am.

Use the arrow buttons to adjust the Daytime mode start time.

Continued Next Page

OPERATION

Set clock and cycle start times continued

5. Save the Daytime start time and advance to the Nighttime start time.

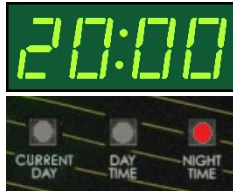

Push the Enter button

- This saves the flashing time value shown on the display as the autocyple Day mode start time.
- The display automatically advances to the Nighttime start time.



Note: The default Night start time is 8:00 pm.

6. Set the start time for the autocyple Nighttime mode.

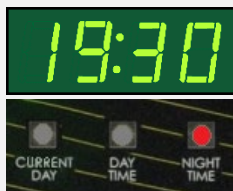

Note: Skip to the next step if you do not wish to adjust the current Nighttime start time.

Use the arrow buttons to adjust the Nighttime mode start time.

Note: 24-hour clock afternoon and evening times are 12 hours greater than the 12-hour clock PM equivalents. Example: 1 PM = 13:00; 6 PM = 18:00; 9 PM = 21:00. 12 AM = 00:00.

7. Save the Nighttime start time.

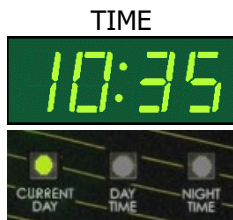

Push Enter button.

- This saves the flashing time value shown on the display as the new autocyple Night mode start time.
- The display automatically exits its time adjustment mode and returns to normal operations.
- The Temperature display turns back on.

End of procedure

OPERATION

SET THE NIGHT MODE TEMPERATURE



This procedure sets the temperature for the Nighttime mode used during both the autcycle and manual operations.

Turn Off the Autocycle

The Night and Day mode temperature setpoints cannot be changed while the Day – Night Autocycle is running. If the cycle is running, turn it off by pushing the Cycle Start button. The Program Active light will extinguish.



1. Set the OTL control to its maximum setting.



Turn the OTL control knob all the way to the right.

Note: This prevents the heating cutoff system from interfering if setting a higher temperature.

2. Put the incubator into Night Mode, if not already running in Night mode.



Press and hold the **Mode** button for 5 seconds to switch to modes.

- The Day Temp indicator will go dark and the blue Night Temp illuminates.

3. Navigate to the Night Mode Temperature Setpoint Adjustment mode

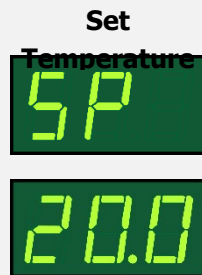

Initial Setpoint

Press and hold either of the arrow buttons.

- The display will show SP, then show the blinking, adjustable Night Mode setpoint.

Note: The display automatically exits the adjustment mode after 5 seconds of inactivity on the arrow keys, saving the last shown setpoint value.

4. Set the Temperature Setpoint



Use the arrow buttons to adjust the flashing setpoint.

Note: To turn off heating and cooling for both modes, set the setpoint to its lowest setting (OFF).

Continued next page

Set the Night Mode Temperature Continued

5. Wait for 5 seconds for the Setpoint to save.



Wait 5 Seconds



- The display will stop flashing. The setpoint is now saved in the controller.
- The display will revert to showing the current chamber air temperature heating or cooling to match the new Night Mode setpoint.



End of procedure

OPERATION



SET THE DAY MODE TEMPERATURE

This procedure sets the temperature for the Daytime mode used during both the autocytle and manual operations.

Turn Off the Autocycle if On

The Day and Night mode temperature setpoints cannot be changed while the Day – Night Autocycle is running. If the cycle is running, turn it off by pushing the Cycle Start button.



Program
Active

1. Set the OTL control to its maximum setting.

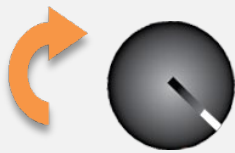

Turn the OTL control knob all the way to the right.

Note: This prevents the heating cutoff system from interfering if setting a higher temperature.

2. Put the incubator in Day Mode, if not already running in Day mode.

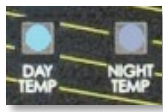

Press and hold the **Mode** button for 5 seconds to switch to modes.

- The Night Temp indicator will turn off, the light blue Day Temp will illuminate.

3. Place the display in its Setpoint Adjustment mode.

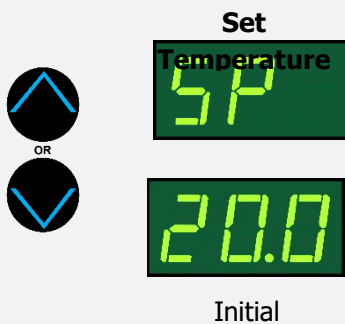

Press and hold either of the arrow buttons.

- The Temperature display will show SP, then the adjustable Day Mode temperature setpoint.

Note: The display automatically exits the adjustment mode after 5 seconds of inactivity on the arrow keys, saving the last shown setpoint value.

4. Set the Day Mode Temperature setpoint.



Use the arrow buttons to adjust the flashing setpoint.

Note: To turn off heating and cooling for both modes, set the setpoint to its lowest setting (OFF).

Continued next page

Set the Day Mode Temperature Continued.

5. Wait for 5 seconds for the Setpoint to save.



Wait 5 Seconds



- The display will stop flashing. The setpoint is now saved in the controller.
- The display will revert to showing the current chamber air temperature heating or cooling to match the new Night Mode setpoint.



See page 53 for how to set the Over Temperature Limit heating cutoff.

OPERATION

Note: Test the OTL heating cutoff system at least once per year for functionality. **Failure to set the OTL voids the manufacturing defect warranty if over temperature damage occurs.**

SET THE OVER TEMPERATURE LIMIT

The incubator temperature must be stable running at temperature in Day Mode for at least 1 hour prior to setting the OTL. Setting the OTL while running in the Night Mode risks tripping the OTL system whenever the unit is switched to the warmer Daytime temperature.



1. Set OTL control to its maximum setting, if not already set to max.



Turn the OTL control knob all the way to the right.

This prevents the heating cutoff system from interfering if setting a higher temperature.

2. Temporarily set the incubator to 1°C above your Day Mode application temperature.

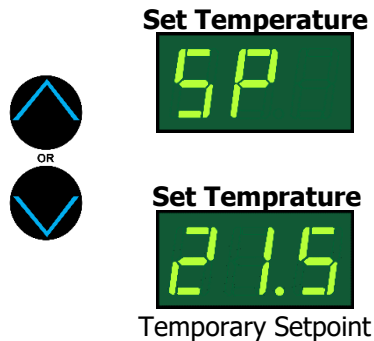

Increase the Day Mode setpoint using the [Set the Day Mode Temperature Setpoint](#) procedure starting on page 51.

- The temperature is increased to ensure the OTL does not interrupt normal Daytime operations.
- The setpoint will be restored to your application temperature in Step 7 of this procedure.

3. Wait at least 1 hour before continuing.

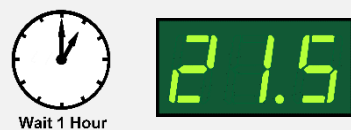

This allows the incubation chamber to achieve the new temperature and an acceptable level of thermal stability.

4. Turn the dial counterclockwise until the red Over Temperature Limit Light illuminates.



Continued next page

OPERATION

Set the Over Temperature Limit Continued

5. Slowly turn the dial clockwise until the OTL Activated light turns off.



6. Leave the OTL dial set just above the activation point.



- The Over Temperature Limit is now set close to the current incubator air temperature

7. Restore the Day Mode setpoint to the temperature of your study application.



Set Temperature



Set Temperature

Restored Application Setpoint

Use the [Set the Day Mode Temperature Setpoint](#) procedure starting on page 51.

If the OTL sporadically activates **after** the incubator has achieved the restored setpoint temperature, you may turn the dial slightly to the right (clockwise).

If the OTL continues activating, check for ambient sources of heat or cold that may be adversely impacting the unit temperature stability. Check if any powered accessories in the workspace chamber are generating heat. If you can find no sources of external or internal temperature fluctuations, contact Tech Support or your distributor for assistance.

End of Procedure

LOADING SAMPLES

The manufacturer strongly recommends waiting at least **8 hours** after putting the unit into operation before loading samples in the incubation chamber. This allows the unit to heat soak, protecting against temperature instability.

- Samples should be placed at least 1 inch (25 mm) away from the chamber walls.
- Proper spacing allows for maximum air circulation and a higher degree of temperature uniformity.
- Proper spacing also decreases the chance of condensate forming in the incubator when operating with a large number of samples in the chamber.

DAY – NIGHT AUTO-CYCLE

Launch the Cycle

- 1 Press and hold the **Cycle Start** button for two seconds.
 - The Program Active indicator will illuminate.
 - The autcycle will now run indefinitely, switching between Day and Night Modes until manually terminated.

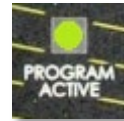

End the Autocycle

- Push and hold the **Cycle Start** button for two seconds.
 - aThe Program Active indicator extinguishes.

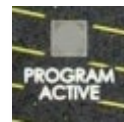

Power Outages

In the event of an outage, the incubator will adjust its clock time automatically when power is restored. If the Autocycle was running at the time of the outage, the cycle will also compensate to match to updated clock time.

CHAMBER POWER OUTLET

Each incubator comes with a 1-amp power outlet inside the chamber. Do not attach powered equipment that draws more than 1 amp.

- The SRI6PF and SRI20PF power outlet provides 100 – 120 volts.
- The SRI6PF-2 and SRI20PF-2 power outlet provides 220 – 240 volts.

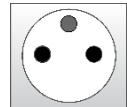

Verify that any powered accessory equipment used inside the chamber can safely and effectively operate within your selected temperature range.

Heat from Powered Equipment: Powered equipment, such as stirrers or shakers, can generate heat sufficient to disrupt the thermal uniformity and stability of the chamber.

HUMIDIFYING THE INCUBATOR

Breathable Sample Containers: Placing a small number of open or breathable media containers in the incubator chamber may lead to excessive drying of sample media. Unusually dry environmental conditions may also contribute to sample drying.

Humidification Kit: SRIPF incubators are supplied with a humidity collection pan and tubing accessory kit: The kit redirects moisture that normally condenses on the heat sink fins of the Peltier TEC-H device and uses it to humidify the incubator.

The humidification kit is intended for use while running **small loads**.

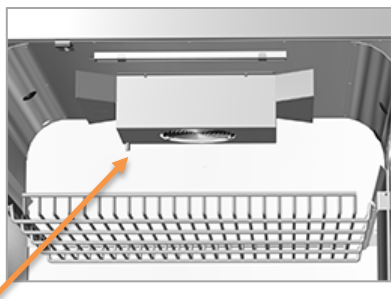

1. Remove the Peltier drain cover.
2. Connect the kit tubing to the port.
3. Run the tubing down behind the shelves.

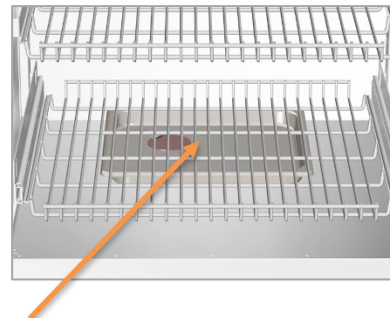

4. Place humidification pan on chamber floor.
5. Place the other end of the tubing in the pan.

CONDENSATION AND THE DEW POINT

Relative humidity inside the incubation chamber should never be allowed to exceed 80% at 25°C. Exceeding this threshold will likely result in condensation and leaks around the incubator and may cause corrosion damage if allowed to continue for any significant length of time.

Condensation takes place whenever the humidity level in the incubation chamber reaches the dew point. The dew point is the level of humidity at which the air cannot hold more water vapor. The warmer the air, the more water vapor it can hold.

As the level of humidity rises in an incubation chamber, condensate will first appear on surfaces that are cooler than the air temperature. Near the dew point, condensate forms on any item or exposed surface even slightly cooler than the air. When the dew point is reached, condensate forms on nearly all exposed surfaces.

Managing condensation primarily depends on either lowering the humidity level or increasing the air temperature in the incubator chamber.

Note: Rising or falling air pressure from the weather will adjust the dew point up and down in small increments. If the relative humidity in the incubation chamber is already near the dew point, barometric fluctuations may push it across the dew threshold.

Note: The thin air at higher altitudes holds less humidity than the denser air found at or near sea level.

If excessive condensate has appeared in the incubation chamber, **dry the chamber interior.** After removing the condensate, check the following.

- Ensure samples on the shelves are evenly spaced to allow for good airflow.
- Ensure the chamber door is closing and latching properly.
- Verify the chamber access port is closed. The black, rubber port stopper that came with the unit should be installed on the inside of the incubator in the chamber.
- Are frequent or lengthy chamber door openings causing significant temperature disruptions and chilling the chamber surfaces? If so, reduce the number of openings.
- Are there too many open or “breathable” containers of evaporating sample media in the chamber? If so, reduce the number of open sample containers.
- Does the ambient humidity in the room exceed the stated operating range of 80% relative environmental humidity? If so, lower the room humidity.
- Is the incubator exposed to an external flow of cold air such as an air-conditioning vent or a door to a cooler hallway or adjacent room? Block or divert the air or reposition the unit.
- Check the door gasket for damage, wear, or signs of brittleness or dryness. Arrange for replacement of the gasket if damaged or excessively worn.

OPERATION

Note: The Day – Night Autocycle must be off when turning the Door Alarm off or on.

Note: Changing the Door Alarm setting accesses the Temperature Setpoint menu but does not adjust the temperature setpoint.

DOOR ALARM SETTING

The incubator comes with a Door Alarm that sounds an audible alarm and causes the temperature display to blink on and off when the door has been open for longer than 60 seconds. The alarm comes from the factory set to On.



Turning the Alarm Off

1. Put the incubator in Temperature Setpoint adjustment mode.



OR



Press and hold either the **Up** or **Down** arrow buttons to activate the temperature setpoint adjustment mode.

- The display will briefly flash the letters "SP", then show the flashing, adjustable temperature setpoint.



Setpoint Adjustment Mode



Temperature Setpoint

Note: The display will automatically exit the adjustment mode after 5 seconds of inactivity without saving any changes.

2. Change the Door Alarm setting to Door Off.



Press and hold the Up button until the display reads "dO". This indicates the Door Alarm has been set to Off.



Door Alarm Off

3. Wait 5 seconds after changing the Door Alarm setting.



Wait 5 Seconds

- The display will revert to showing the current chamber air temperature.

The door alarm is now set to Off. The temperature setpoint has not been changed.



Temperature Setpoint

Turning the Alarm On

- Follow the steps above to access the Temperature Setpoint adjustment mode.
- For Step 2, press and hold the Up button until the display reads "dI" to change the Door Alarm setting to On.

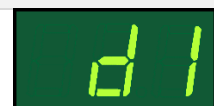

Door Alarm On

End of Procedure

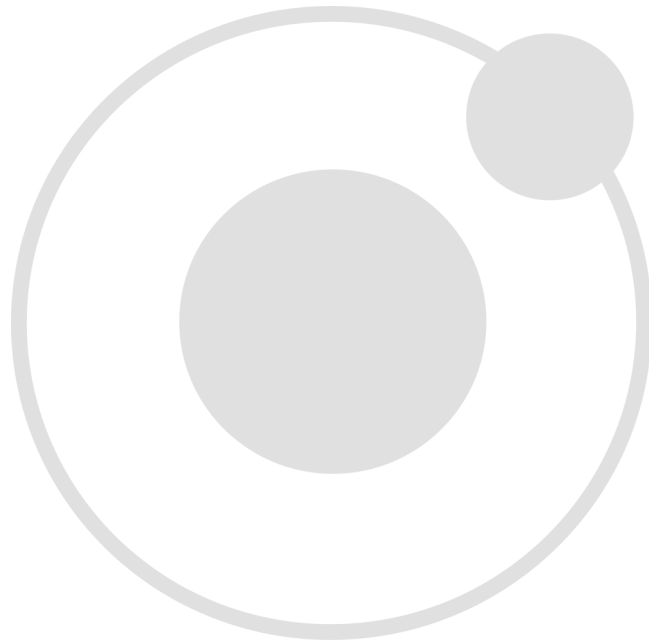

Warning: Disconnect this unit from its power supply prior to performing maintenance or services.

Avertissement: Débranchez cet appareil de son alimentation électrique avant d'effectuer la maintenance ou les services.



CLEANING AND DISINFECTING

If a hazardous material or substance has spilled in the unit chamber, immediately initiate your site Hazardous Material Spill Containment protocol. Contact your local Site Safety Officer and follow instructions per the site policy and procedures.

- Periodic cleaning and disinfection are required.
- Do not use spray-on cleaners or disinfectants. These can leak through openings and coat electrical components.
- Consult with the manufacturer or their agent if you have any doubts about the compatibility of decontamination or cleaning agents with the parts of the equipment or with the material contained in it.
- Do not use cleaners or disinfectants that contain solvents capable of harming paint coatings or stainless steel surfaces. **Do not use chlorine-based bleaches or abrasives; these will damage the chamber liner.**

Warning: Exercise caution if cleaning the unit with alcohol or flammable cleaners. Always allow the unit to cool down to room temperature prior to cleaning and make sure all cleaning agents have evaporated or otherwise been completely removed prior to putting the unit back into service.

Avertissement: Soyez prudent lorsque vous nettoyez l'appareil avec de l'alcool ou des produits de nettoyage inflammables. Laissez toujours refroidir l'appareil à la température ambiante avant le nettoyage et assurez-vous que tous les produits de nettoyage se sont évaporés ou ont été complètement enlevés avant de remettre l'appareil en service.



Cleaning

1. Disconnect the unit from its power supply.
2. Remove all removable interior components such as shelving and accessories.
3. Clean the unit with a mild soap and water solution, including all corners.
 - **Do not use an abrasive cleaner**, these will damage metal surfaces.
 - **Do not use deionized water to rinse or clean with.**
 - Take special care when cleaning around the temperature sensor probes in the chamber to prevent damage. Do not clean the probes.
4. Rinse with distilled water and wipe dry with a soft cloth.

Disinfecting

For maximum effectiveness, disinfection procedures are typically performed after cleaning. Keep the following points in mind when disinfecting the unit.

- Turn off and disconnect the unit to safeguard against electrical hazards.
- Disinfect the unit chamber using commercially available disinfectants that are non-corrosive, non-abrasive, and suitable for use on stainless steel and glass surfaces. Contact your local Site Safety Officer for detailed information on which disinfectants are compatible with your applications.
- If permitted by your protocol, remove all removable interior accessories (shelving and other non-attached items) from the chamber when disinfecting.
- Disinfect all surfaces in the chamber, making sure to thoroughly disinfect the corners. Exercise care to avoid damaging the sensor probes.

When disinfecting external surfaces, use disinfectants that will not damage painted metal, glass, and plastic.

DOOR COMPONENTS

Periodically, inspect the door latch, trim, catch, and gaskets for signs of deterioration. Failure to maintain the integrity of the door system shortens the life span of the incubator.

ELECTRICAL COMPONENTS

Electrical components do not require maintenance. If the incubator fails to operate as specified, please contact your distributor or [Technical Support](#) for assistance.

CALIBRATE THE TEMPERATURE DISPLAY

Note: Performing a temperature display calibration requires a temperature reference device. Please see the [Reference Sensor Device entry](#) on page 12 for the device requirements.



Temperature calibrations are performed to match the incubator temperature display to the actual air temperature inside the incubation chamber. The actual air temperature is supplied by a calibrated reference device. Calibrations compensate for long-term drifts in the incubator microprocessor controller as well as those caused by the natural material evolution of the sensor probe in the heated incubator space. Calibrate as often as required by your laboratory or production protocol, or regulatory compliance schedule. Always calibrate to the standards and use the calibration setup required by your industry requirements or laboratory protocol.

The Day and Night Modes must be separately calibrated. These are separate setpoints, which automatically adjust for extra heat produced by the Day Mode LED array or its absence.

A suggested calibration setup

1. Introduce the reference device thermocouple sensor probe through the access port on the back of the incubator into the incubation chamber.

2. Position the sensor probe head as close as possible to the geometric center point of the chamber. incubation chamber with the probe heads at least 2 inches (51 mm) above the shelving to avoid heatsinking.

Secure all probes in place with non-stick, heat-resistant tape.

3. After securing the probe in position, carefully place the access port stopper in the port over the probe wire. Use non-stick tape to seal any gaps created between the stopper and the port by the probe

4. The incubation chamber door must be closed and latched. Failure to do so will prevent an accurate calibration.



Use non-marking, heat-resistant polyamide tape to hold the thermocouple probe in place. The manufacturer recommends Kapton brand tape, 0.5 inches width (12 mm), 2 mil thickness.

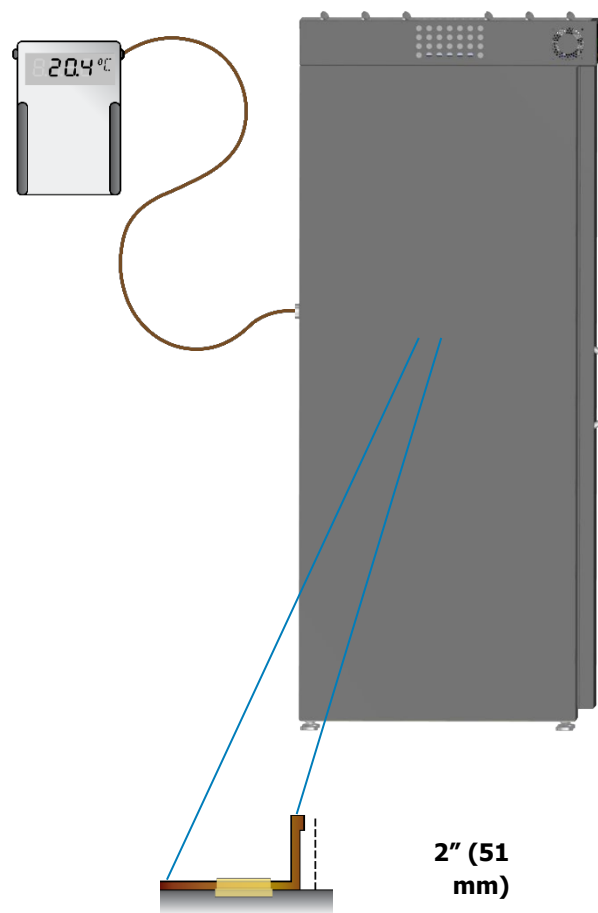

5. Autocycle Off

- The Autocycle must be turned off to conduct stable, accurate temperature calibrations for the Day and Night Modes.

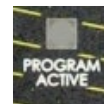

MODE

6. Set to Day Mode

- Place the incubator in Day Mode. This prepares the unit to calibrate the temperature display to the Day Mode temperature setpoint.



7. Temperature Stabilization

- Allow the incubator to operate undisturbed with the door shut and in Day Mode for **at least 8 hours** when first putting the unit into operation in a new environment.
- To be considered stabilized, the incubator chamber must operate at your calibration temperature for **at least 1 hour with no fluctuations of $\pm 0.1^\circ\text{C}$ or greater.**

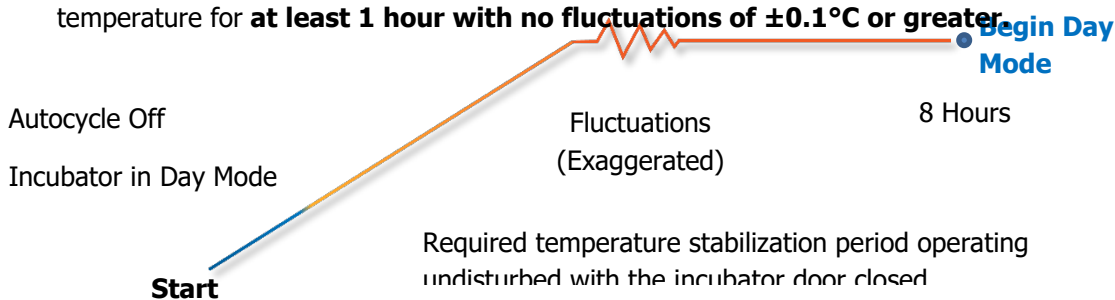

Suggested Day Mode Temperature Calibration

1

Once the incubator temperature has stabilized at your Day Mode temperature, compare the reference device and incubator temperature display readings.

- If the readings are the same, or the difference between the two falls within the acceptable range of your protocol, the display is accurately showing the Day Mode air temperature with the Day Mode illumination lights on. **Advance to page 53 to start the Night Mode calibration.**

Reference Device

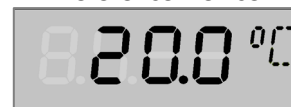

Set Temperature

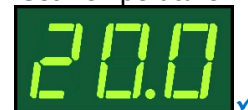

- Or -

- If a difference falls outside of your protocol range, advance to step 2.

2

A display calibration adjustment must be entered to match the display to the reference device. See next step.

Reference Device

22.1 °C

20.0 x

Day Mode Temperature Calibration Continued

3

Place the display in its temperature calibration mode for Day Mode.

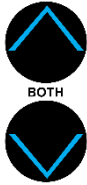

- Press and hold both the **UP and DOWN** arrow buttons simultaneously for approximately 5 seconds.
- Release the buttons when the temperature display shows the letters "C O". The display will begin flashing the **current temperature display value**.

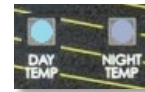

Note: The display will automatically exit calibration mode after 5 seconds of inactivity, with the last shown temperature display value saved.

4



Use the **Up or Down** arrows to adjust the current display temperature value until it matches the reference device temperature reading.

Reference Device

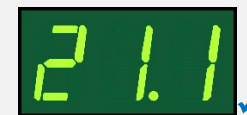
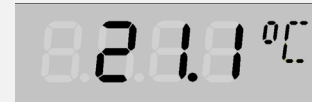

5

After matching the display to the reference device, wait 5 seconds.



Wait 5 Seconds

- The temperature display will cease flashing and store the corrected chamber display value.
- The incubator will now begin heating or cooling to reach the setpoint with the corrected display value.



Cooling to Setpoint

6



Wait 1 Hour

After the incubator has achieved the corrected temperature, allow the chamber to stabilize sitting at least one 1 hour undisturbed.

- Failure to wait until the incubator is fully stabilized will result in an inaccurate reading.



Setpoint Achieved

Continued next page

Day Mode Temperature Calibration Continued

7

Compare the reference device reading with the chamber temperature display again.

- If the reference device and the chamber temperature display readings are the same or the difference falls within the range of your protocol, the incubator is calculated for Day Mode temperature. **Advance to page 53** and begin the calibration test for the Night Mode.

Reference Device



- OR -

- See the next step if the readings fail to match or fall outside of your protocol range.

8

If the two readings are not the same, and the difference still falls outside the acceptable range of your protocol, repeat steps 3 – 7 up to two more times.

Three calibration attempts may be required to successfully calibrate units that are more than $\pm 2^{\circ}\text{C}$ out of calibration.

Reference Device



9

If the Day Mode temperature readings of the incubator temperature display and the reference device still fall outside your protocol after three calibration attempts, contact your incubator distributor or **Technical Support** for assistance.

Reminder: The unit must still be calibrated for Night Mode.

Continued Next Page

Night Mode Temperature Calibration

1 Put the incubator into night mode.



- a. Press and hold the **Mode** button for 5 seconds to switch to modes.
- The Day Temp indicator light turns off and the Night Temp light turns on.



2 Allow the incubator to achieve the Night Mode temperature and stabilize.

- a. Wait a minimum of 2 Hours.
- The incubator is considered stabilized when it has run at the Night Mode temperature with no fluctuations of $\pm 0.1^{\circ}\text{C}$ for 1 hour.

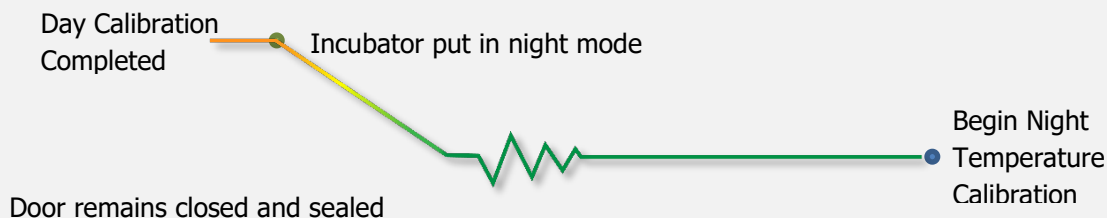

3

Once the incubator temperature has stabilized at your Night Mode temperature, compare the reference device and incubator temperature display readings.

- If the readings are the same, or the difference between the two falls within the acceptable range of your protocol, the display is accurately showing the Night Mode air temperature with the Day Mode illumination lights Off. **The calibration procedure is complete.**

Reference Device



Set Temperature



- Or -

- If the difference falls outside of your protocol range, advance to the next step.

4

A display calibration adjustment must be entered to match the display to the reference device. See next step.

Reference Device

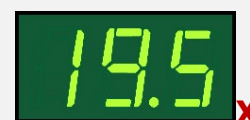

Continued next page

Night Mode Temperature Calibration Continued

3

Place the display in its temperature calibration mode for Night Mode.

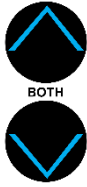

- Press and hold both the **UP and DOWN** temperature arrow buttons simultaneously for approximately 5 seconds.
- Release the buttons when the temperature display shows the letters "C O". The display will begin flashing the **current temperature display value**.



Note: If an arrow key is not pressed for five seconds, the display will cease flashing, and store the last displayed number as the new current chamber temperature value.

4

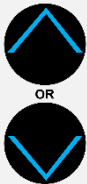

Use the **Up** or **Down** arrows to adjust the current display temperature value until it matches the reference device temperature reading.

Reference Device

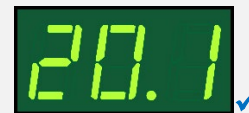

5

After matching the display to the reference device, wait 5 seconds.



Wait 5 Seconds

- The temperature display will cease flashing and store the corrected chamber display value.
- The incubator will now begin heating or cooling to reach the setpoint with the corrected display value.

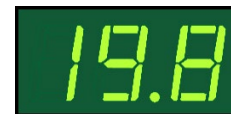

Cooling to Setpoint

6



Wait 1 Hour

After the incubator has achieved the corrected temperature, allow the chamber to sit at least one 1 hour undisturbed to stabilize.

- Failure to wait until the incubator is fully stabilized will result in an inaccurate reading.



Setpoint Achieved

Continued next page

Night Mode Temperature Calibration Continued

7

Compare the reference device reading with the chamber temperature display again.

- If the reference device and the chamber temperature display readings are the same or the difference falls within the range of your protocol, the incubator is calculated for Night Mode temperature. **The calibration procedure is complete.**

Reference Device

19.5 °C

19.5 ✓

- OR -

- See the next step if the readings fail to match or fall outside of your protocol range.

8

If the two readings are not the same, and the difference still falls outside the acceptable range of your protocol, repeat steps 3 – 7 for the Night Mode temperature calibration up to two more times.

Three calibration attempts may be required to successfully calibrate units that are more than $\pm 2^{\circ}\text{C}$ out of calibration.

Reference Device

19.8 °C

19.5 ✗

9

If the Night Mode temperature readings of the incubator temperature display and the reference device still fall outside your protocol after three calibration attempts, contact your incubator distributor or [Technical Support](#) for assistance.

End of procedure

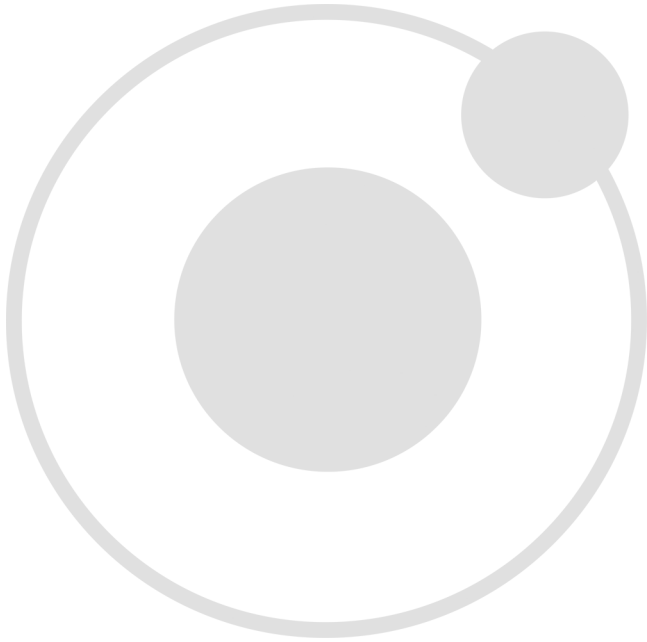

UNIT SPECIFICATIONS

The SRI6PF and SRI20PF incubators are 110 – 120 voltage units. The SRI6PF-2 and SRI20PF-2 are 220 – 240 voltage models. Please refer to the individual unit data plate for electrical specifications.

Technical data specified applies to units with standard equipment at an ambient temperature of 25°C and a voltage fluctuation of ±10%. The temperatures specified are determined in accordance with factory standards following DIN 12880 respecting the recommended wall clearances of 10% of the height, width, and depth of the inner chamber. All indications are average values, typical for units produced in the series. We reserve the right to alter technical specifications at all times.

WEIGHT

Model	Shipping	Net Weight
SRI6PF	205 lbs. / 93 kg	125.0 lbs / 56.7 kg
SRI20PF	408 lbs. / 185 kg	246.0 lbs / 111.6 kg

DIMENSIONS

In Inches

Model	Exterior W × D × H	Interior W × D × H
SRI6PF	30.0 x 31.5 x 33.5 in	25.5 x 24.0 x 18.5 in
SRI20PF	30.0 x 31.5 x 69.5 in	25.5 x 24.0 x 54.5 in

In Millimeters

Model	Exterior W × D × H	Interior W × D × H
SRI6PF	762 x 800 x 851 mm	648 x 610 x 470 mm
SRI20PF	762 x 800 x 1766 mm	648 x 610 x 1384 mm

CAPACITY

Model	Cubic Feet	Liter
SRI6PF	6.5	185.5
SRI20PF	19.3	546.6

SPECIFICATIONS

SHELF CAPACITY BY WEIGHT

Model	Per Shelf*	Total**
SRI6PF	75.0 lbs / 34.0 kg	150.0 lbs / 68.0 kg
SRI20PF	75.0 lbs / 34.0 kg	375.0 lbs / 170.0 kg

*Weight distributed evenly across the shelf.

**Exceeding this weight limit risks damaging the shelf standard rails and the chamber liner.

POWER

100 – 120 Volt Models

Model	AC Voltage	Amperage	Frequency
SRI6PF	100 – 120	4.0 Amps	50/60 Hz
SRI20PF	100 – 120	5.5 Amps	50/60 Hz

220 – 240 Volt Models

Model	AC Voltage	Amperage	Frequency
SRI6PF-2	220 – 240	3.0 Amps	50/60 Hz
SRI20PF-2	220 – 240	3.5 Amps	50/60 Hz

TEMPERATURE

Model	Chamber Temp Range	Uniformity	Stability
SRI6PF	15° to 40°C @ 25°C Ambient*	±0.5° @ 20°C	±0.1°C @ 20°C
SRI20PF	15° to 40°C @ 25°C Ambient*	±0.5° @ 20°C	±0.1°C @ 20°C





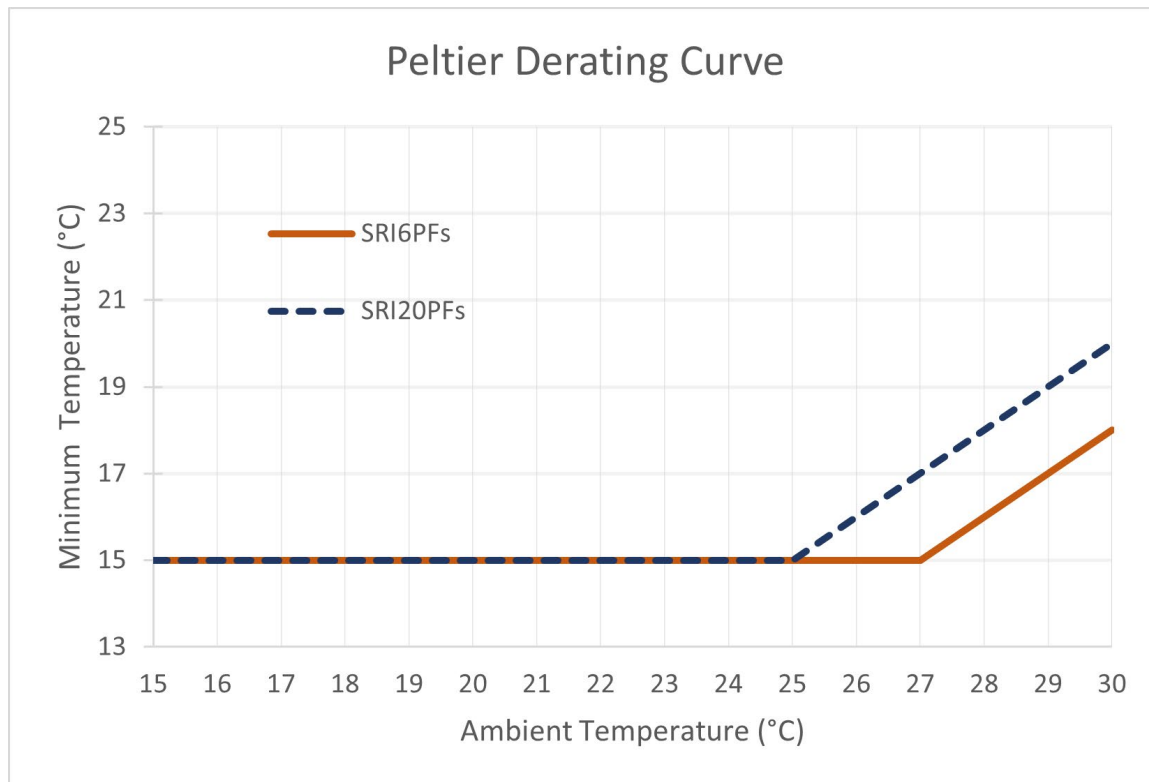

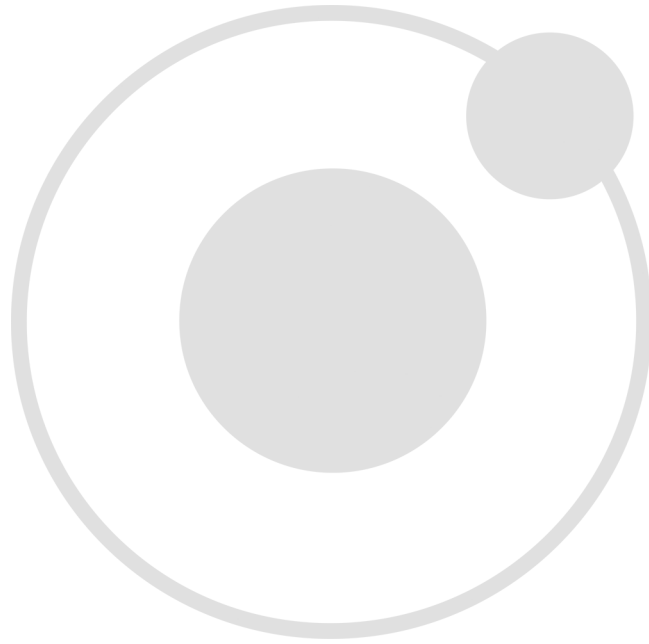



*Workspace temperatures can affect the lowest achievable operating temperature.

- SRI6PF:** Sustained ambient temperatures of 27.1°C (80.7°F) and hotter will impact the low-end temperature performance of the SRI6P. The lowest sustainable temperature rises as the workspace temperature rises. See the graph on this page.
- SRI20PF:** Sustained ambient temperatures of 25.1°C (77.1°F) and hotter will impact the low-end temperature performance of the SRI20P. The lowest sustainable temperature rises as the workspace temperature rises. See the graph on this page.



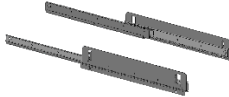

PARTS AND CONSUMABLES

Description	Part Number	Description	Part Number
Access Port Stopper	 7750517	Power Cord, 125V SRI6PF, SRI20PF 15 Amp, 8ft 2in (2.5m), NEMA 5-15P	 1800510
Feet, Adjustable Glide	 2700506	Power Cord 250V SRI6PF-2, SRI20PF-2 10 Amp, 2.5m (8ft 2 inches), Euro CEE7/7	 1800500
Fuse 250V T6.3A, 5X20mm (220V units require 2)	 3300515	Shelf, 1	 6800525
SRI6PF: Magnetic Door Gasket (29" x 26")	 3450743	Static Shelf Bracket, 1	 5221213
SRI20PF: Magnetic Door Gasket (29" x 62")	 3450732	Sliding Shelf Brackets, 2	 9490584
Humidity Reservoir Pan	 7930514		

Ordering

Accessories and replacement parts can be ordered online at parts.sheldonmfg.com.

If the required item is not listed online, or if you require assistance in determining which part or accessory you need contact SHEL LAB by emailing parts@sheldonmfg.com or by calling 1-800-322-4897 ext. 3 or (503) 640-3000 ext. 3.

Please have the **model**, **serial**, and **part** numbers of the unit ready. Customer Support needs this information to match your unit to its correct part.

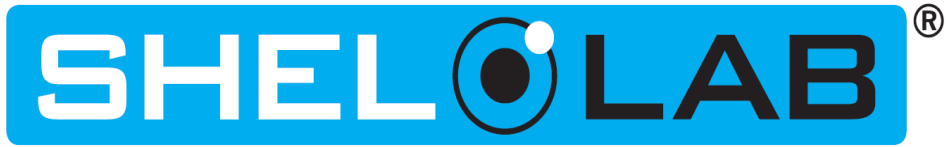

P.O. Box 627
Cornelius, OR 97113
USA

support@sheldonmfg.com
sheldonmanufacturing.com



1-800-322-4897
(503) 640-3000